

GX-K series

GF-K series

High resolution industrial balance

INSTRUCTION MANUAL

GX-K series

GX-8K, GX-12K, GX-30K
GX-8K2, GX-20K, GX-32K

GF-K series



GF-8K, GF-12K, GF-30K
GF-8K2, GF-20K, GF-32K

AND

A&D Company, Limited

This Manual and Marks

All safety messages are identified by the following, "WARNING" or "CAUTION", of ANSI Z535.4 (American National Standard Institute: Product Safety Signs and Labels). The meanings are as follows:

| | |
|---|---|
|  WARNING | A potentially hazardous situation which, if not avoided, could result in death or serious injury. |
|  CAUTION | A potentially hazardous situation which, if not avoided, may result in minor or moderate injury. |



This is a hazard alert mark.

- This manual is subject to change without notice at any time to improve the product.
- The contents of the product specifications and this manual are subject to change without any obligation on the part of the manufacturer.
- Under the copyright laws, the software (program) described in it are copyrighted, with all rights reserved.
The software may be installed into one computer and may not be installed into other computers without the prior written consent of A&D Company. Copying includes translation into another language, reproduction, conversion, photocopy and offer or loan to another person.

- Microsoft, Windows, Word, Excel is a registered trademark of the Microsoft Corporation.

© 2004 A&D Company, Limited All rights reserved.

No part of this publication may be reproduced, transmitted, transcribed, or translated into any language in any form by any means without the written permission of A&D Company Ltd.

Contents

Basic Operation

| | | |
|------|--|----|
| 1. | Introduction | 3 |
| 1-1. | About This Manual | 3 |
| 1-2. | Features | 3 |
| 1-3. | Compliance | 4 |
| 2. | Unpacking And Installing The Balance | 5 |
| 2-1. | Installing The Balance | 6 |
| 3. | Precautions | 6 |
| 3-1. | Before Use | 6 |
| 3-2. | During Use | 7 |
| 3-3. | After Use | 8 |
| 3-4. | Power Supply | 8 |
| 4. | Display Symbols and Key Operation | 9 |
| 4-1. | Smart Range Function | 10 |
| 5. | Weighing Units | 11 |
| 5-1. | Units | 11 |
| 5-2. | Changing the Units | 14 |
| 6. | Weighing | 15 |
| 6-1. | Basic Operation (Gram Mode) | 15 |
| 6-2. | Counting Mode (PCS) | 16 |
| 6-3. | Percent Mode (%) | 18 |
| 6-4. | Animal Weighing Mode (Hold Function) | 18 |
| 6-5. | Accumulation Function | 19 |

Adapting To The Environment

| | | |
|------|--|----|
| 7. | Weighing Speed Adjustment / Self Check Function | 21 |
| 7-1. | Weighing Speed Adjustment | 21 |
| 7-2. | Self Check Function With Response Adjustment For The GX-K Series | 22 |
| 7-3. | Self Check Function For GF-K Series | 22 |
| 8. | Calibration | 23 |
| 8-1. | Calibration Group | 23 |
| 8-2. | Automatic Self Calibration For The GX-K Series | 24 |
| 8-3. | One-Touch Calibration For The GX-K Series | 25 |
| 8-4. | Calibration Using An External Weight | 26 |
| 8-5. | Calibration Test Using An External Weight | 27 |
| 8-6. | Correcting The Internal Mass Value Of The GX-K Series | 28 |

Selecting Functions

| | | |
|-------|---|----|
| 9. | Function Switch And Initialization | 30 |
| 9-1. | Permit Or Inhibit | 30 |
| 9-2. | Initializing The Balance | 31 |
| 10. | Function Table | 32 |
| 10-2. | Details Of The Function Table | 34 |
| 10-3. | Description Of The Class "Environment, Display" | 37 |
| 10-4. | Description Of The Item "Data Output Mode" | 39 |

| | | |
|------------------------------------|--|----|
| 10-5. | Description Of The Item "Data Format" | 40 |
| 10-6. | Data Format Examples | 43 |
| 10-7. | Clock And Calendar Function | 45 |
| 10-8. | Comparator Function | 46 |
| 11. | ID Number And GLP Report..... | 53 |
| 11-1. | Setting The ID Number | 53 |
| 11-2. | GLP Report..... | 54 |
| 12. | Data Memory | 57 |
| 12-1. | Notes on Using Data Memory | 57 |
| 12-2. | Data Memory for Weighing Data | 58 |
| 12-3. | Data Memory for Calibration and Calibration Test | 61 |
| 12-4. | Data Memory for Unit Mass in the Counting Mode..... | 62 |
| 12-5. | Data Memory for Comparator Settings | 65 |
| 12-6. | Data Memory for Tare Value | 68 |
| 12-7. | Data Memory: Quick Selection Mode | 71 |
| 12-8. | Data Memory: Confirmation and Storage Mode..... | 72 |
| 13. | Underhook | 74 |
| 14. | Programmable Unit | 75 |
| 15. | Density Measurement..... | 76 |
| Interface And Communication | | |
| 16. | Standard Input & Output Interface | 80 |
| 16-1. | RS-232C And External Contact Input | 80 |
| 16-2. | Connection to peripheral equipment | 82 |
| 17. | Commands | 84 |
| 17-1. | Command List | 84 |
| 17-2. | Acknowledge Code And Error Codes | 85 |
| 17-3. | Control Using CTS And RTS | 86 |
| 17-4. | Settings Related To RS-232C | 86 |
| Maintenance | | |
| 18. | Maintenance | 87 |
| 18-1. | Treatment Of The Balance | 87 |
| 19. | Troubleshooting..... | 88 |
| 19-1. | Checking The Balance Performance And Environment..... | 88 |
| 19-2. | Error Codes | 89 |
| 19-3. | Other Display | 91 |
| 19-4. | Asking For Repair | 91 |
| 20. | Specifications..... | 92 |
| 20-1. | External Dimensions | 94 |
| 20-2. | Options and Peripheral Instruments..... | 95 |
| 21. | Terms/Index | 97 |
| 21-1. | Terms..... | 97 |
| 21-2. | Index..... | 99 |

1. Introduction

This manual describes how the balances of the GX-K series and GF-K series work and how to get the most out of them in terms of performance.

Read this manual thoroughly before using the balance and keep it at hand for future reference.

1-1. About This Manual

This manual consists of the following five parts:

- Basic operationDescribes precautions, the balance's construction and basic operation.
- Adapting to the environmentDescribes response (and stability) adjustment to adapt to the environment where there is vibration or drafts, the way to maintain weighing precision in a variation of ambient temperature, calibration and calibration test.
- FunctionsDescribes functions of the balance.
- RS-232C serial interfaceDescribes the RS-232C serial interface and external contact input. The RS-232C serial interface can communicate with a computer that requests weighing data and controls the balance. This RS-232C interface is for use with a computer or printer. The external contact input commands the balance re-zeroing and data output.
- MaintenanceDescribes maintenance, error codes, troubleshooting, specifications and options.

1-2. Features

- Large vacuum fluorescent display (VFD), easy to read.
- Dust-tight and protected against water jets, allows washing with water. A waterproof RS-232C cable (GX-07K) is available as an option.
- Built-in calibration weight (hereinafter referred to as the internal mass) of the GX-K series, allows easy calibration, adjustment and maintenance of the balance.
- Automatic self calibration of the GX-K series, using the internal mass, adapting to changes in temperature.
- Automatic self-check function to check itself by one key operation.
- The response speed of the GX-K series, adapting to drafts and vibration after self-checking the balance.

- High response speed: The time to read a displayed value after a sample is placed on the pan has been shortened by using a super hybrid sensor (SHS).
Approximately 1.5 seconds when **FAST** is selected for the response rate.
- Data memory function stores weighing data, calibration data or unit mass in the counting mode. It can also store tare values or upper and lower limit values for the comparator function.
Interval memory mode is provided to store the weighing data periodically.
- Good laboratory practice (GLP) data can be output using the standard RS-232C serial interface.
- GX-K series has a built-in clock and calendar that can add the time and date to the output data.
- Comparator Indicators, displaying the comparison results, **HI**, **OK** or **LO**.
- Capacity Indicator, displaying the weight value in percentage relative to the weighing capacity.
- Hold function, provided for weighing a moving object such as an animal.
- Multiple weighing units with most of the common units used around the world.
- Density mode, for calculating the density of a solid.
- Accumulation function, adding the weight values and outputting the sum.
- Standard RS-232C serial interface to communicate with a computer.
- Windows communication tools software (WinCT) to allow easy communication with Windows.
- Reference card, provided for a quick reference to the balance operation.
- Underhook, available as an option, for measuring density and weighing magnetic materials.
- Comparator output (GX-04K) and analog voltage output (GX-06K) are available as options.
- Breeze break (AX-GXK-31), can be used for a precision weighing, is provided for GX-8K, GX-8K2, GF-8K and GF-8K2.

1-3. Compliance

1-3-1. Compliance With FCC Rules

Please note that this equipment generates, uses and can radiate radio frequency energy. This equipment has been tested and has been found to comply with the limits of a Class A computing device pursuant to Subpart J of Part 15 of FCC rules. These rules are designed to provide reasonable protection against interference when equipment is operated in a commercial environment. If this unit is operated in a residential area, it may cause some interference and under these circumstances the user would be required to take, at his own expense, whatever measures are necessary to eliminate the interference.

(FCC = Federal Communications Commission in the U.S.A.)

1-3-2. Compliance With EMC Directives

CE This device features radio interference suppression in compliance with valid EC Regulation 89/336/EEC.

2. Unpacking And Installing The Balance

- The balance is a precision instrument. Unpack the balance carefully. Keep the packing material to be used for transporting the balance in the future.
- The packing contents depend on the balance model. See the illustrations to confirm that everything is contained.

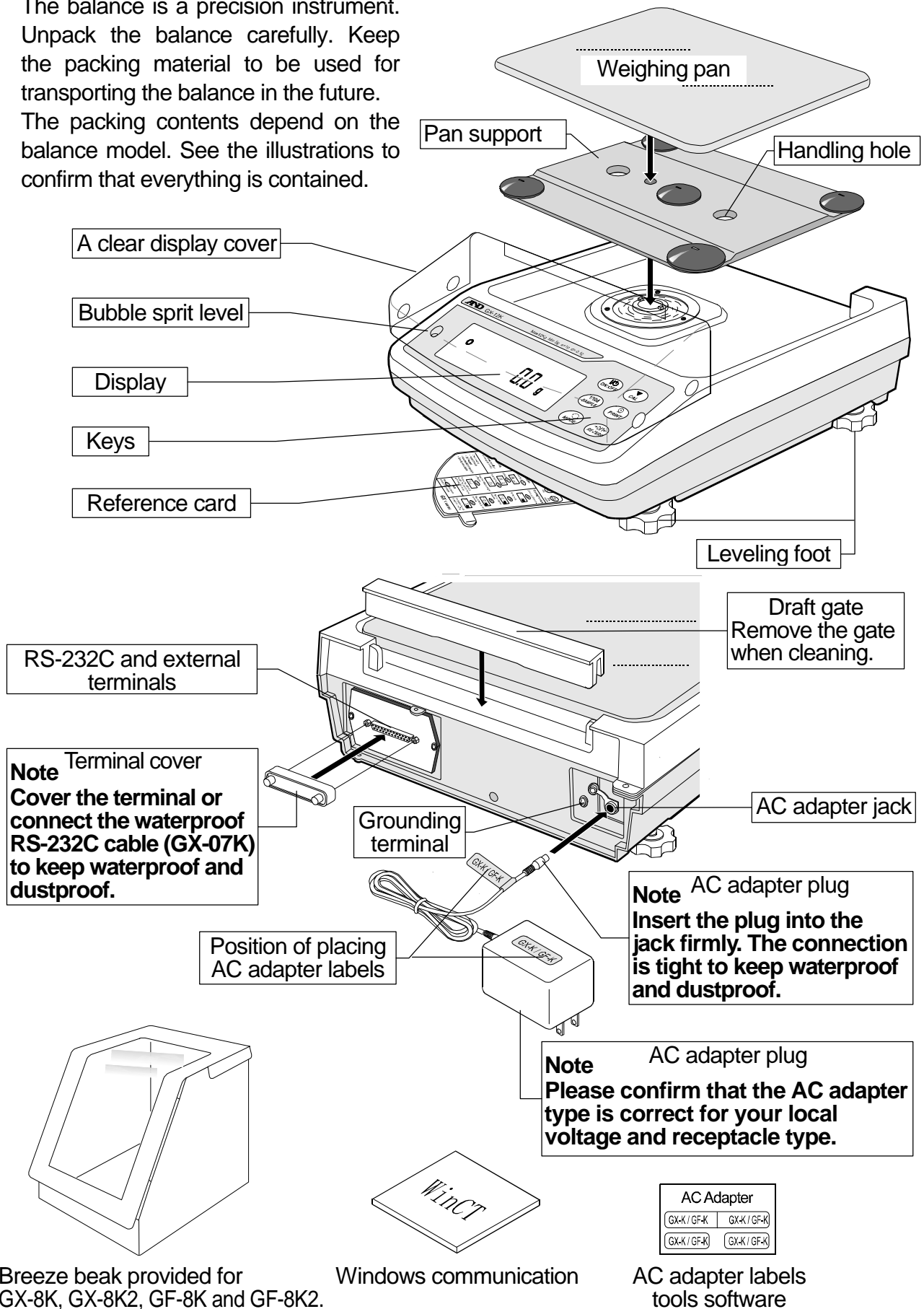

2-1. Installing The Balance

Install the balance as follows:

- 1 Refer to "**3. Precautions**" for installing the balance.
- 2 Install the pan support, weighing pan and draft gate. Refer to the previous page.
- 3 Adjust the leveling feet to level the balance. Confirm it using the bubble spirit level.
- 4 Confirm that the AC adapter type is correct for the local voltage and power receptacle type.
- 5 Connect the AC adapter to the balance firmly. Earth the balance. Warm up the balance for at least 30 minutes with nothing on the weighing pan.

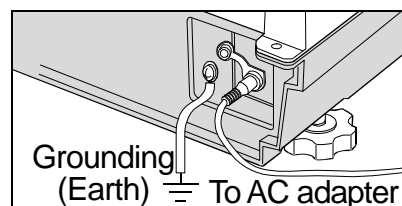
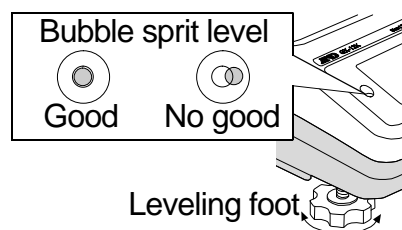

3. Precautions

To get the optimum performance from the balance and acquire accurate weighing data, note the following:

3-1. Before Use

- The maximum resolution of the precision balance is eighty million counts. Therefore, there are tendencies to be influenced by temperature change, air pressure change, vibration and drafts where the balance is placed.
- Install the balance in an environment where the temperature and humidity are not excessive. The best operating temperature is about 20°C / 68°F at about 50% relative humidity.
- Install the balance where it is not exposed to direct sunlight and it is not affected by heaters or air conditioners.
- Install the balance where it is free of dust.
- Install the balance away from equipment that produces magnetic fields.
- Install the balance in a stable place avoiding vibration and shock. Corners of rooms on the first floor are best, as they are less prone to vibration.
- The weighing table should be solid and free from vibration, drafts and as level as possible.
- Level the balance by adjusting the leveling feet and confirm it using the bubble spirit level.
- Ensure a stable power source when using the AC adapter.
- Connect the AC adapter and warm up the balance for at least 30 minutes.
- Calibrate the balance periodically for accurate weighing.
- When the balance is installed for the first time or has been moved, warm up the balance for at least 6 hours to allow the balance to reach equilibrium with the ambient temperature, and then perform calibration before use.

- The meaning of IP-65 is "No ingress of dust. Projected against water jets". If a powerful water jet is used or the balance is immersed in water, it may cause a damage that is due to ingress of water.
- Confirm that "the plug is inserted firmly into the jack" and "the terminal is covered using the waterproof cover or the waterproof RS-232C cable (GX-07K)", when using the balance.
- Use the waterproof option cable GX-07K, when the RS-232C interface is used with IP-65. AX-KO1710-200, a standard RS-232C cable, is not waterproof or dustproof.
- Confirm that the weighing pan does not touch to rim.

⚠ Do not install the balance where flammable or corrosive gas is present.

3-2. During Use

- Discharge static electricity from the material to be weighed (hereinafter referred to as the sample). When a sample could have a static charge, the weighing data is influenced. Try to keep the ambient humidity above 45%RH or use the metal shield case.
- This balance uses a strong magnet as part of the balance assembly, so please use caution when weighing magnetic materials such as iron. If there is a problem, use the underhook on the bottom of the balance to suspend the material away from the influence of the magnet.
- Eliminate any temperature difference between the sample and the environment. When a sample is warmer (cooler) than the ambient temperature, the sample will be lighter (heavier) than the true weight. This error is due to a rising (falling) draft around the sample.
- Make each weighing gently and quickly to avoid errors due to changes in the environmental conditions.
- Do not drop things upon the weighing pan, or place a sample on the pan that is beyond the balance weighing capacity. Place the sample in the center of the weighing pan.
- Do not use a sharp instrument such as a pencil to press the keys. Use your finger only.
- Press the **RE-ZERO** key before each weighing to prevent possible errors.
- Calibrate the balance periodically so as to eliminate possible errors.
- Take into consideration the affect of air buoyancy on a sample when more accuracy is required.
- It is possible to check the reference card for principle operation.
- Prevent foreign matter, such as powder, liquid and metal, from invading the area around the weighing pan.
- Use the "breeze break" for a precision weighing.

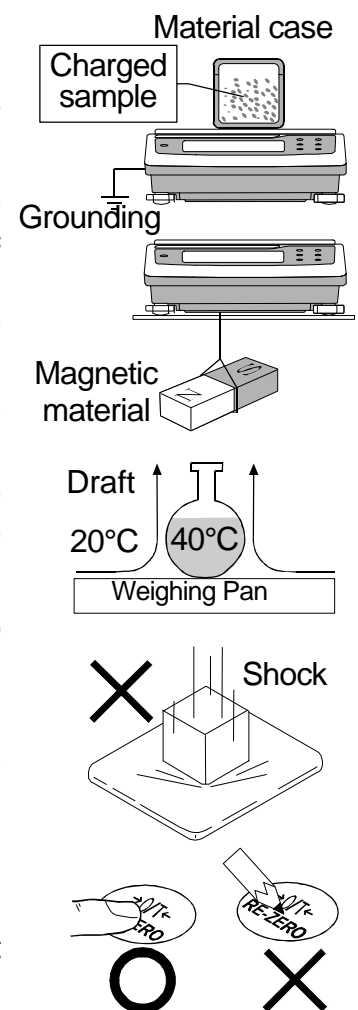

3-3. After Use

- Avoid mechanical shock to the balance.
- Do not disassemble the balance. Contact the local A&D dealer if the balance needs service or repair.
- Do not use organic solvents to clean the balance. Clean the balance with a lint free cloth that is moistened with warm water and a mild detergent.
- Do not allow the balance to be immersed in water. Even though the balance complies with IP code, the balance will not withstand being completely immersed in water.
- The weighing pan, pan support and draft gate can be removed to clean the balance. Clean by splashing with water.
- Use the waterproof option RS-232C cable GX-07K, when RS-232C interface is used with IP-65. AX-KO1710-200, a standard RS-232C cable, is not waterproof or dustproof.

3-4. Power Supply

- Do not remove the AC adapter while the internal mass is in motion, for example, right after the AC adapter is connected, or during calibration using the internal mass. If the AC adapter is removed under the conditions described above, the internal mass will be left unsecured, that may cause mechanical damage when the balance is moved. Before removing the AC adapter, press the **ON:OFF** key and confirm that zero is displayed.
- When the AC adapter is connected, the balance is in the standby mode if the standby indicator is on. This is a normal state and does not harm the balance. For accurate weighing, keep the AC adapter connected to the balance and AC power unless the balance is not to be used for a long period of time.

4. Display Symbols and Key Operation

Key Operations

- Key operation affects how the balance functions. The basic key operations are:
 - "Press and release the key immediately" or "Press the key" are normal operation. = normal key operation during measurement
 - "Press and hold the key".

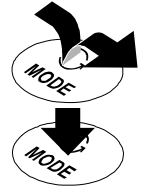

Display

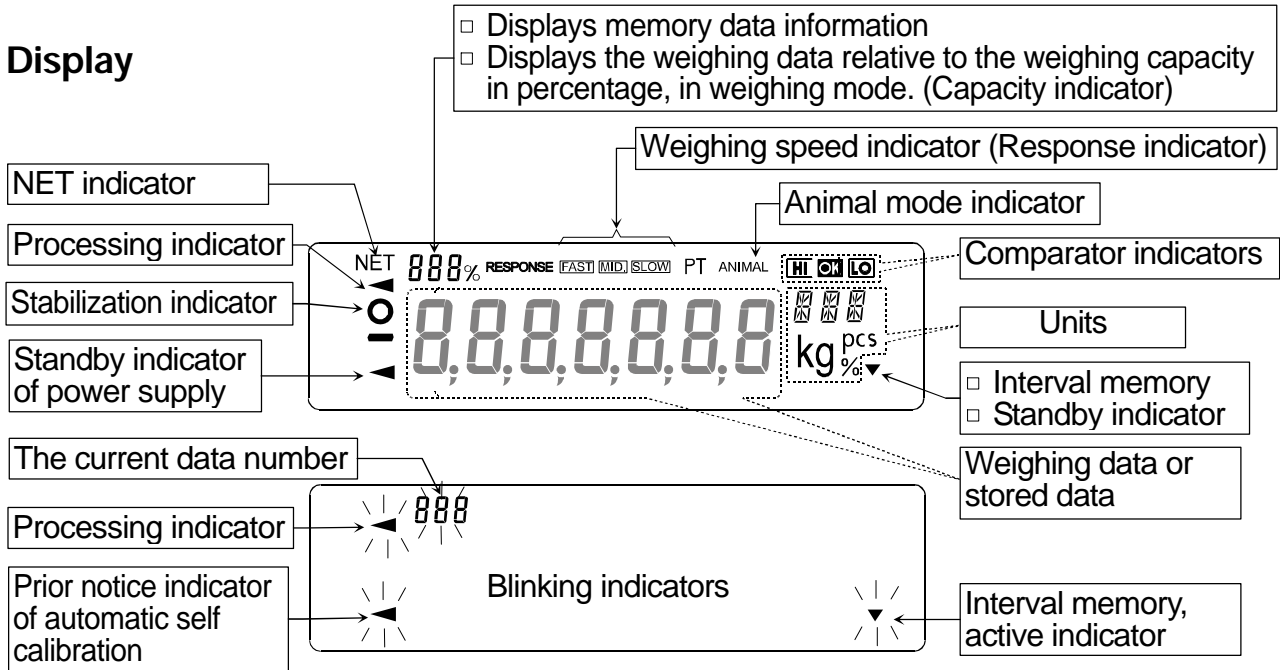

Each key, when pressed or when pressed and held, functions as follows:

| Key | When pressed and released | When pressed and held |
|-----|--|---|
| | Turns the display ON and OFF. The standby indicator is displayed when the display is turned off. The weighing mode is enabled when the display is turned on. This key is available anytime. Pressing the key during operation will interrupt the operation and turn the display OFF. | |
| | In the weighing mode, turns the minimum weighing value ON and OFF. In the counting or percent mode, enters the sampling mode. | Enters the function table mode. Refer to "10. Function Table". |
| | Switches the preset weighing units stored in the function table. Refer to "5 Weighing Units". | Performs weighing speed adjustment (response adjustment) and self check. |
| | Performs calibration using the internal mass for GX-K series. | Displays other items of the calibration menu. |
| | Stores the weighing data in memory or outputs to a printer or personal computer depending on the function table settings. (Factory setting = output) | No function at the factory setting. By changing the function table: <ul style="list-style-type: none"> Outputs "Title block" and "End block" for GLP report. Displays the data memory menu. |
| | Sets the display to zero. | |

4-1. Smart Range Function

- The GX-32K, GF-32K, GX-8K2 and GF-8K2 are equipped with two ranges of "precision range" of a higher resolution and "standard range" of normal resolution.
- The range is switched automatically depending on the value displayed. Pressing the **RE-ZERO** key allows weighing in the precision range, regardless of the tare value. (Smart range function)
- The range can be fixed to the standard range, by pressing the **SAMPLE** key.

Note

- **Once the range is switched to the standard range, it will not switch to the precision range automatically even when the displayed value becomes within the precision range value. Press the **RE-ZERO** or **SAMPLE** key to use the precision range again.**

Example

GX-32K or GF-32K, precision range = 6.1 kg x 0.1g, standard range = 31 kg x 1 g.

- Step 1 Press the **RE-ZERO** key.
The balance will start weighing, using the precision range.
- Step 2 Place a container on the weighing pan.
When the weighing value exceeds the precision range, the range will be switched to the standard range.
- Step 3 Press the **RE-ZERO** key.
The balance will be switched to the precision range.
- Step 4 Place a sample on the pan.
When the weighing value is within the precision range, the balance will perform a weighing using the precision range.

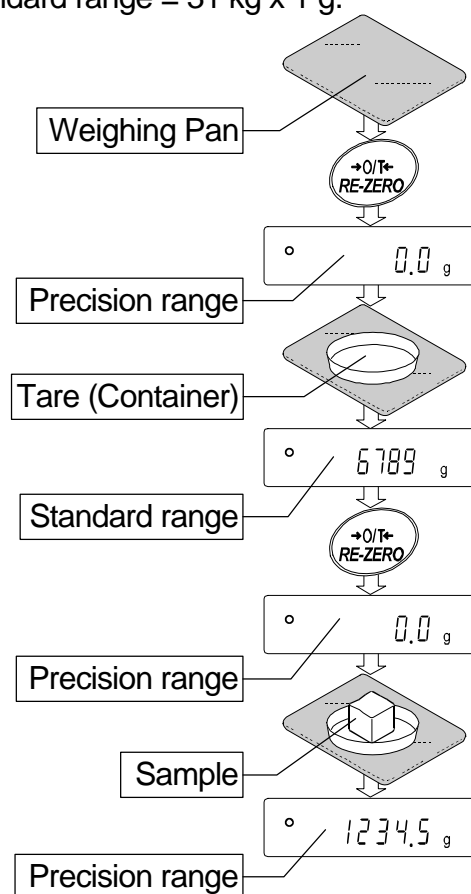

Precision range/standard range value

| | GX-32K / GF-32K | GX-8K2 / GF-8K2 |
|--|-----------------|--------------------|
| Precision range (after RE-ZERO key is pressed) | Up to 6100.9 g | Up to 2100.09 g |
| Standard range | 6101 to 31008 g | 2100.1 to 8100.8 g |

5. Weighing Units

5-1. Units

- With the balance, the following weighing units and weighing modes are available :

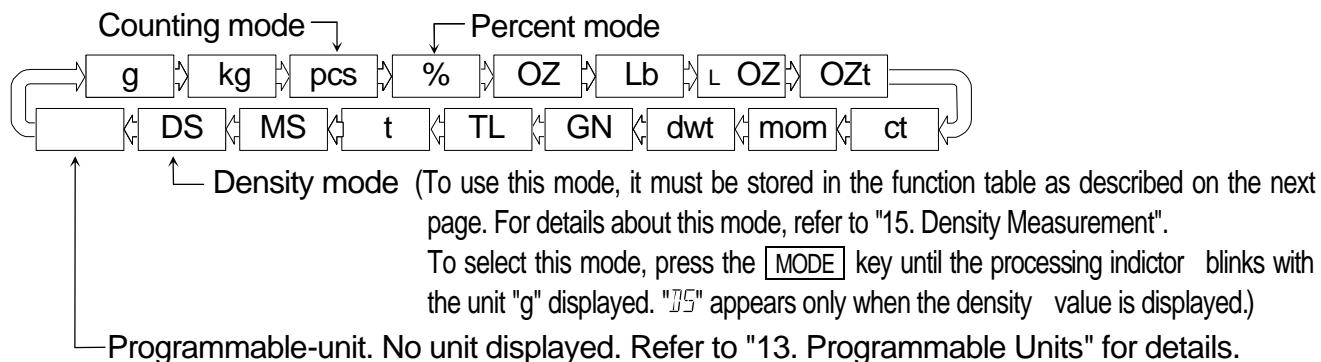

A unit or mode can be selected and stored in the function table as described in "5-2.Changing the Units".

If a weighing mode (or unit of weight) has been turned off, that mode or unit will be missing in the sequence. Tael has four varieties, one of which can be selected and installed at the factory.

To select a unit or mode for weighing, press the **MODE** key.

For details about the units and modes, see the table below:

| Name (unit, mode) | Abbreviation | Display | Function table (Storing mode) | Conversion factor 1 g = |
|--------------------------------|--------------|---------------------------------------|-------------------------------|--|
| Gram | g | g | g | 1 g |
| kilogram | kg | kg | kg | 1000 g |
| Counting mode | pcs | pcs | pcs | - |
| Percent mode | % | % | % | - |
| Ounce (Avoir) | OZ | <i>OZ</i> | <i>OZ</i> | 28.349523125 g |
| Pound | Lb | <i>Lb</i> | <i>Lb</i> | 453.59237 g |
| Pound/Ounce | L OZ | <i>L OZ</i> | <i>LO</i> | 1 Lb = 16 oz, 1 oz = 28.349523125 g |
| Troy Ounce | OZt | <i>OZt</i> | <i>OZt</i> | 31.1034768 g |
| Metric Carat | ct | <i>ct</i> | <i>ct</i> | 0.2 g |
| Momme | mom | <i>mom</i> | <i>mom</i> | 3.75 g |
| Pennyweight | dwt | <i>dwt</i> | <i>dwt</i> | 1.55517384 g |
| Grain (UK) | GN | <i>GN</i> | <i>GN</i> | 0.06479891 g |
| Tael (HK general, Singapore) | TL | <i>TL</i> | <i>TL</i> | 37.7994 g |
| Tael (HK jewelry) | | | | 37.429 g |
| Tael (Taiwan) | | | | 37.5 g |
| Tael (China) | | | | 31.25 g |
| Tola (India) | t | <i>t</i> | <i>t</i> | 11.6638038 g |
| Messghal | MS | <i>MS</i> | <i>MS</i> | 4.6875 g |
| Density mode | DS | <i>DS</i> is used to show the density | <i>DS</i> | - |
| Programmable-unit (Multi-unit) | Mlt | — | <i>Mlt</i> | - |

Note The unit Grain is not available for the GX-32K and GF-32K.

- The tables below indicate the weighing capacity and the minimum display for each unit, depending on the balance model.

| Unit | GX-12K GF-12K | GX-20K GF-20K | GX-30K GF-30K | Minimum display |
|------------------------------|------------------|------------------|------------------|-----------------|
| | Capacity | | | |
| Gram | 12000.0 | 21000.0 | 31000.0 | 0.1 |
| Kilogram | 12.0000 | 21.0000 | 31.0000 | 0.0001 |
| Ounce (Avoir) | 423.290 | 740.755 | 1093.495 | 0.005 |
| Pound | 26.4555 | 46.2970 | 68.3435 | 0.0005 |
| Pound/Ounce | 26L 7.29 | 46L 4.75 | 68L 5.49 | 0.01 |
| Troy Ounce | 385.810 | 675.165 | 996.675 | 0.005 |
| Metric Carat | 60000.0 | 105000.0 | 155000.0 | 0.5 |
| Momme | 3200.00 | 5600.00 | 8266.65 | 0.05 |
| Pennyweight | 7716.2 | 13503.3 | 19933.5 | 0.1 |
| Grain (UK) | 185188 | 324080 | 478404 | 2 |
| Tael (HK general, Singapore) | 317.465 | 555.565 | 820.120 | 0.005 |
| Tael (HK jewelry) | 320.605 | 561.060 | 828.235 | 0.005 |
| Tael (Taiwan) | 320.000 | 560.000 | 826.665 | 0.005 |
| Tael (China) | 384.000 | 672.000 | 992.000 | 0.005 |
| Tola (India) | 1028.82 | 1800.44 | 2657.80 | 0.01 |
| Messghal | 2560.00 | 4480.00 | 6613.35 | 0.05 |

| Unit | GX-8K GF-8K | |
|------------------------------|----------------|-----------------|
| | Capacity | Minimum display |
| Gram | 8100.00 | 0.01 |
| Kilogram | 8.10000 | 0.00001 |
| Ounce (Avoir) | 285.7190 | 0.0005 |
| Pound | 17.85745 | 0.00005 |
| Pound/Ounce | 17L 13.719 | 0.001 |
| Troy Ounce | 260.4210 | 0.0005 |
| Metric Carat | 40500.00 | 0.05 |
| Momme | 2160.000 | 0.005 |
| Pennyweight | 5208.42 | 0.01 |
| Grain (UK) | 125002.2 | 0.2 |
| Tael (HK general, Singapore) | 214.2890 | 0.0005 |
| Tael (HK jewelry) | 216.4095 | 0.0005 |
| Tael (Taiwan) | 216.0000 | 0.0005 |
| Tael (China) | 259.2000 | 0.0005 |
| Tola (India) | 694.456 | 0.001 |
| Messghal | 1728.000 | 0.005 |

| Unit | GX-8K2 GF-8K2 | | | |
|------------------------------|------------------|-----------------|-----------------|-----------------|
| | Standard range | | Precision range | |
| | Capacity | Minimum display | Capacity | Minimum display |
| Gram | 8100.00 | 0.1 | 2100.00 | 0.01 |
| Kilogram | 8.1000 | 0.0001 | 2.10000 | 0.00001 |
| Ounce (Avoir) | 285.720 | 0.005 | 74.0755 | 0.0005 |
| Pound | 17.8575 | 0.0005 | 4.62970 | 0.00005 |
| Pound/Ounce | 17L 13.72 | 0.01 | 4L 10.075 | 0.001 |
| Troy Ounce | 260.420 | 0.005 | 67.5165 | 0.0005 |
| Metric Carat | 40500.0 | 0.5 | 10500.00 | 0.05 |
| Momme | 2160.00 | 0.05 | 560.000 | 0.005 |
| Pennyweight | 5208.4 | 0.1 | 1350.33 | 0.01 |
| Grain (UK) | 125002 | 2 | 32408.0 | 0.2 |
| Tael (HK general, Singapore) | 214.290 | 0.005 | 55.5565 | 0.0005 |
| Tael (HK jewelry) | 216.410 | 0.005 | 56.1060 | 0.0005 |
| Tael (Taiwan) | 216.000 | 0.005 | 56.0000 | 0.0005 |
| Tael (China) | 259.200 | 0.005 | 67.2000 | 0.0005 |
| Tola (India) | 694.46 | 0.01 | 180.044 | 0.001 |
| Messghal | 1728.00 | 0.05 | 448.000 | 0.005 |

| Unit | GX-32K GF-32K | | | |
|------------------------------|------------------|-----------------|-----------------|-----------------|
| | Standard range | | Precision range | |
| | Capacity | Minimum display | Capacity | Minimum display |
| Gram | 31000 | 1 | 6100.0 | 0.1 |
| Kilogram | 31.000 | 0.001 | 6.1000 | 0.0001 |
| Ounce (Avoir) | 1093.50 | 0.05 | 215.170 | 0.005 |
| Pound | 68.345 | 0.005 | 13.4480 | 0.0005 |
| Pound/Ounce | 68L 5.5 | 0.1 | 13L 7.17 | 0.01 |
| Troy Ounce | 996.65 | 0.05 | 196.120 | 0.005 |
| Metric Carat | 155000 | 5 | 30500.0 | 0.5 |
| Momme | 8266.5 | 0.5 | 1626.65 | 0.05 |
| Pennyweight | 19933 | 1 | 3922.4 | 0.1 |
| Grain (UK) | — | — | — | — |
| Tael (HK general, Singapore) | 820.10 | 0.05 | 161.380 | 0.005 |
| Tael (HK jewelry) | 828.25 | 0.05 | 162.975 | 0.005 |
| Tael (Taiwan) | 826.65 | 0.05 | 162.665 | 0.005 |
| Tael (China) | 992.00 | 0.05 | 195.200 | 0.005 |
| Tola (India) | 2657.8 | 0.1 | 522.99 | 0.01 |
| Messghal | 6613.5 | 0.5 | 1301.35 | 0.05 |

5-2. Changing the Units

- The units or modes can be selected and stored in the function table. The sequence of displaying them can be arranged in the function table, so as to fit the frequency of use.

Select a unit or mode and arrange the sequence of display as follows:

Step 1 Press and hold the **[SAMPLE]** key until **[ba5fnc]** of the function table is displayed in the weighing mode, then release the key.

Step 2 Press the **[SAMPLE]** key several times to display **[Unit]**.

Step 3 Press the **[PRINT]** key to enter the unit selection mode.

Step 4 Specify a unit or mode in the order to be displayed using the following keys.

[SAMPLE] key.....To display the units sequentially.

[RE-ZERO] key.....To specify a unit or mode. The stabilization indicator **[°]** appears when the displayed unit or mode is specified.

Step 5 Press the **[PRINT]** key to store the units or modes. The balance displays **[end]** and then displays the next menu item of the function table.

Step 6 Press the **[CAL]** key to exit the function table. Then the balance returns to the weighing mode with the selected unit.

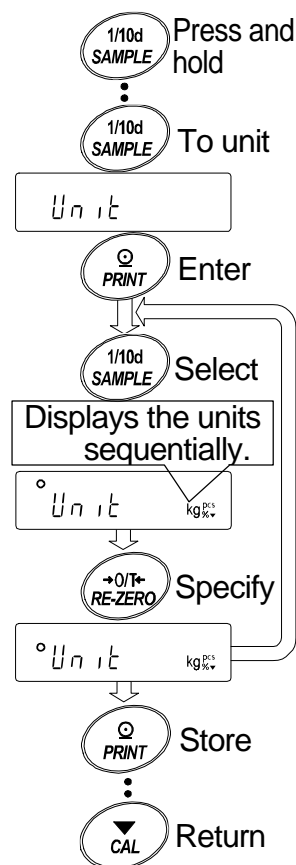

6. Weighing

6-1. Basic Operation (Gram Mode)

- Step 1 Place a container on the weighing pan, if necessary.
Press the **RE-ZERO** key to cancel the weight (tare). The balance displays **00 g**.
(The decimal point position depends on the balance model.)
- Step 2 Place a sample on the pan or in the container.
- Step 3 Wait for the stabilization indicator **°** to be displayed. Read the value.
- Step 4 Remove the sample and container from the weighing pan.

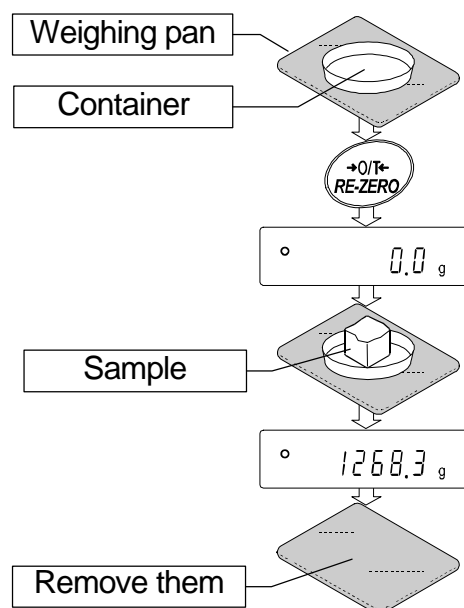

Notes

- To use another unit, press the **MODE** key and select an appropriate unit.
- Press the **SAMPLE** key to turn on or off the minimum weighing value.
- The weighing data can be stored in memory. Refer to "12. Data Memory" for details.

6-2. Counting Mode (PCS)

- This is the mode to determine the number of objects in a sample based on the standard sample unit mass. The unit mass means an average mass of the samples. The smaller the variation in the samples, the more accurate the count will be. The balance is equipped with the Automatic Counting Accuracy Improvement (ACAI) function to improve the counting accuracy.

Note

If the sample unit mass variable, the difference from sample to sample, is too large, it may cause a counting error.

Selecting The Counting Mode

Step 1 Press the **MODE** key to select the unit **pcs** (counting mode).

Storing A Sample Unit Mass (Weighing Input Mode)

Step 2 Press the **SAMPLE** key to enter the sample unit mass storing mode.

Step 3 To select the number of samples using the **SAMPLE** key. It may be set to 10, 25, 50 or 100.

Advise A greater number of samples will yield a more accurate counting result.

Step 4 Place a container on the weighing pan, if necessary. Press the **RE-ZERO** key to cancel the weight (tare). The number specified in step 3 appears.
Example: **25 0** pcs is displayed if 25 is selected in step 3.

Step 5 Place the number of samples specified on the pan. In this example, 25 pieces.

Step 6 Wait for the stabilization indicator to come on. Press the **PRINT** key to calculate and store the unit mass. Then the balance displays **25 pcs** and is set to count samples with this unit mass. (The sample unit mass stored, even if the AC adapter is removed, is maintained in non-volatile memory.) To improve the accuracy of the unit mass, go to step 8.

Notes

- If the balance judges that the mass of the samples is too light and can not be stored as the unit mass, it displays **10**.
- If the balance judges that the mass of the samples is too light to acquire accurate weighing, it displays an error requiring the addition of more samples to the specified number.
Example: **50 - pcs** appears, requiring 25 more samples. Add 25 samples and press the **PRINT** key. When the unit mass is stored correctly, the balance goes to the counting mode.
- The unit mass can be input numerically. Refer to "12-4-1. Storing the unit mass".

Counting Operation

Step 7 Place the samples to be counted on the pan.

Advise Multiple unit masses can be stored in the balance. Refer to "12. Data Memory".
GX-K series.....50 units, GF-K series..... 20 units

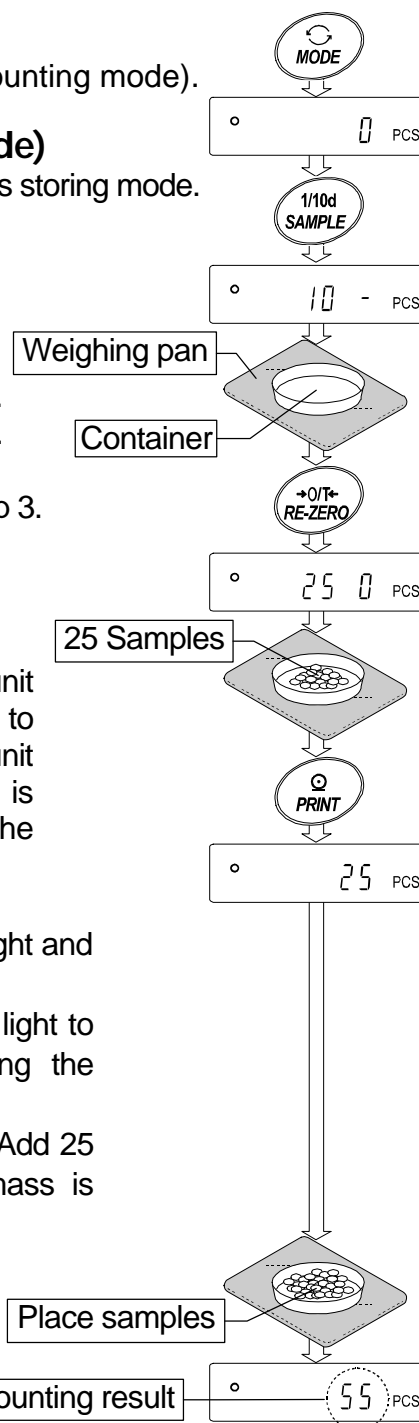

Counting Mode Using The ACAI Function

The ACAI is a function that improves the accuracy of the unit mass automatically by increasing the number of samples as the counting process.

ACAI: Automatic Counting Accuracy Improvement

- Step 8 If a few more samples are added, the processing indicator turns on. To prevent an error, add three or more. The processing indicator does not turn on if overloaded. Try to add the same number of samples as displayed.
- Step 9 The balance re-calculates the unit mass while the processing indicator is blinking. Do not touch the balance or samples on the pan until the processing indicator turns off.
- Step 10 Counting accuracy is improved when the processing indicator turns off. Each time the above operation is performed, a more accurate unit mass will be obtained. There is no definite upper limit of ACAI range for the number of samples exceeding 100. Try to add the same number of samples as displayed.
- Step 11 Remove all the samples used in ACAI and proceed with the counting operation using the improved unit mass.

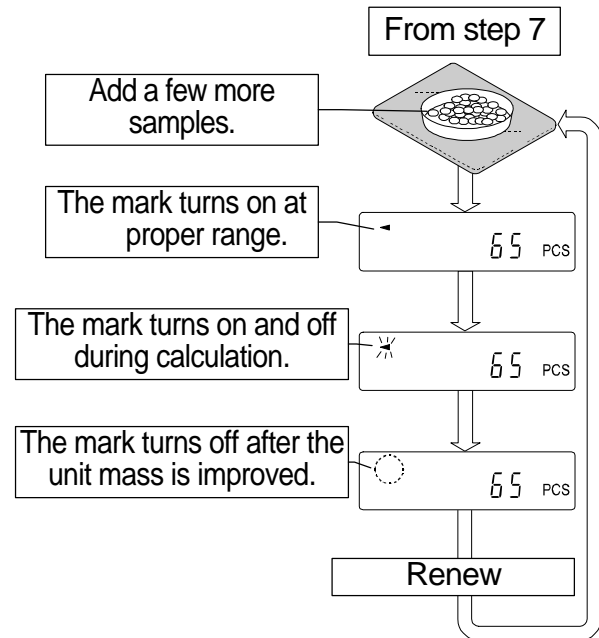

Note ACAI will not function on the unit mass entered using the keys, or digital input mode.

6-3. Percent Mode (%)

The percent mode displays the weighting value in percentage compared to a 100% reference mass and is used for target weighing or checking the sample variance.

Selecting The Percent Mode

- Step 1 Press the **MODE** key to select the unit **%** (Percent mode). If the percent mode can not be selected, refer to "5. Weighing Units".

Storing The 100% Reference Mass

- Step 2 Press the **SAMPLE** key to enter the 100% reference mass storing mode. Even in the storing mode, pressing the **MODE** key will switch to the next mode.
- Step 3 Place a container on the weighing pan, if necessary. Press the **RE-ZERO** key to cancel the weight (tare). The balance displays **100 0 %**.
- Step 4 Place the sample to be set as the 100% reference mass on the pan or in the container.
- Step 5 Press the **PRINT** key to store the reference mass. The balance displays **10000 %**. (The decimal point position depends on the reference value. The reference mass stored, even if the AC adapter is removed, is maintained in non-volatile memory.)

Note

- If the balance judges that the mass of the sample is too light to be used as a reference, it displays **1o**.

- Step 6 Remove the sample.

Reading The Percentage

- Step 7 Place a sample to be compared to the reference mass on the pan. The displayed percentage is based on the 100% reference mass.

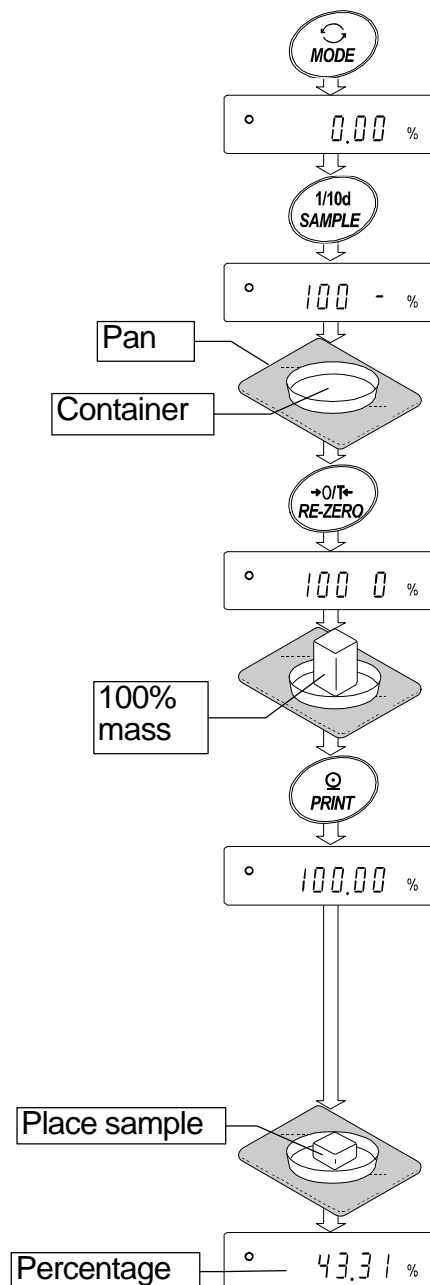

6-4. Animal Weighing Mode (Hold Function)

This is the mode to weigh a moving object such as an animal, even when the display of the weighing data fluctuates. The hold function allows the average weight of the animal to be displayed. To use the hold function, set the function in the function table. Refer to "10. Function Table" and "10-3. Description Of The Class "Environment, Display" " for details.

6-5. Accumulation Function

The accumulation function sums the weighing data and displays the total value.

To use the accumulation function, set the "Accumulation function (add)" parameter of the function table as described below.

Note

While the accumulation function is in use, the data memory function is not available. When using the accumulation function, make sure that the "Data memory (data)" parameter of the function table is set to "0".

Selecting The Unit

Step 1 Press the **MODE** key to select a unit to be used for accumulation.

Note While the accumulation function is in use, unit selection using the **MODE** key is not available.

Setting The Function Table

Step 2 Press and hold the **SAMPLE** key until **ba5fnc** of the function table is displayed, then release the key.

Step 3 Press the **PRINT** key.

Step 4 Press the **SAMPLE** key several times to display **add 0**.

Step 5 Press the **RE-ZERO** key to display **add 1**.

Note To disable the accumulation function, set the "Accumulation function (add)" parameter to "0".

Step 6 Press the **PRINT** key to store the setting.

Step 7 Press the **CAL** key to return to the weighing mode.

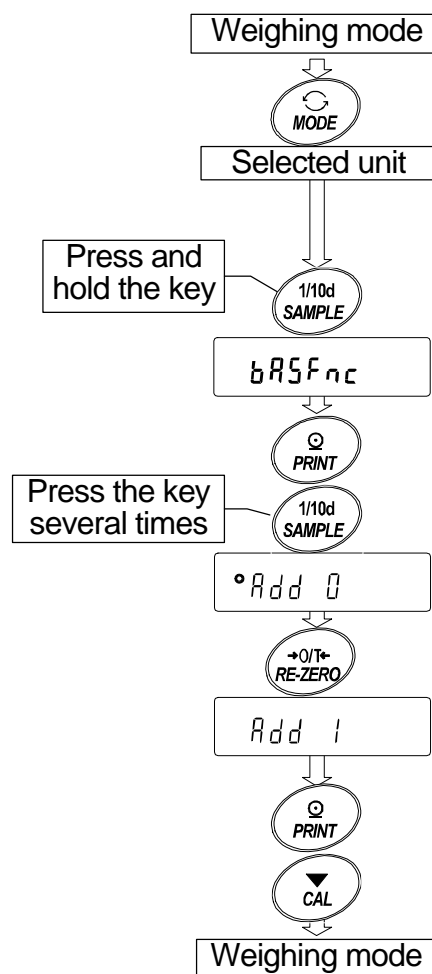

Using The Accumulation Function

Use the following keys to operate the accumulation function.

- MODE** key Displays the weighing data and the total value alternately each time it is pressed.
While the accumulation function is in use, the unit can not be changed.
- RE-ZERO** key .. Sets the display to zero while the weighing data is displayed.
Deletes the total value while the total value is displayed.
- PRINT** key Outputs and adds the weighing data while the weighing data is displayed.
Outputs the total value while the total value is displayed.

- Step 1 Press the **RE-ZERO** key to zero the display.
- Step 2 Place a sample on the pan. The weight value is displayed.
- Step 3 Press the **PRINT** key. The weight value is added to the total and is output.
The accumulation number at the upper left of the display increases by one.
- Step 4 Repeat steps 1 to 3, when accumulating more data.
- Step 5 Press the **MODE** key to display the total value.

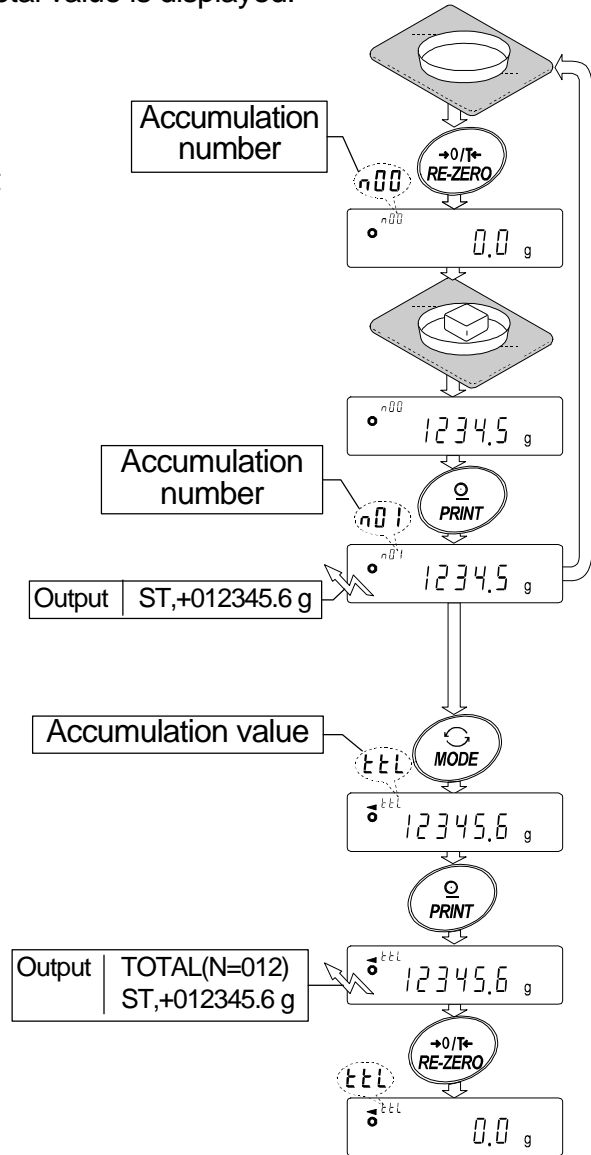

Outputting the value

- Step 6 Press the **PRINT** key to output the total value.
- Step 7 Press the **RE-ZERO** key to delete the total value.

Notes And Displaying Or Outputting An Overloaded Total

- The output format depends on the function table setting.
- While the accumulation function is in use, the data memory function is not available.
- To disable the accumulation function, set the "Accumulation function (add)" parameter to "0".
- When the "Data number output (d-no)" parameter is set to "1", the accumulation number will be output before the weighing data.

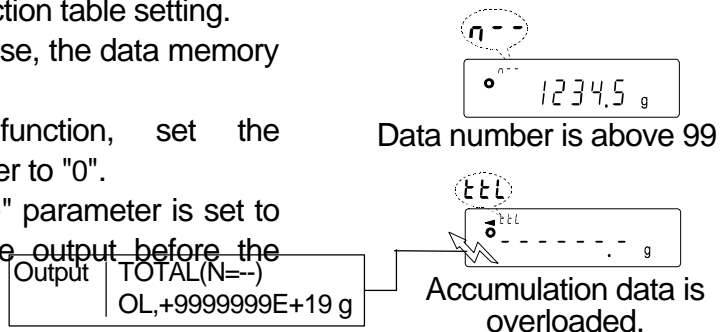

7. Weighing Speed Adjustment / Self Check Function

7-1. Weighing Speed Adjustment

This function detects the influence on weighing that is caused by drafts and/or vibration at the place where the balance is installed and sets the following three weighing speeds (response characteristics) automatically.

The function has three rates as follows:

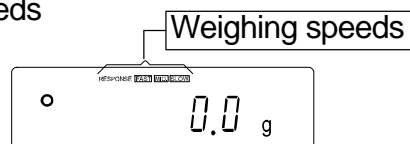

Changing the weighing speed changes the display refresh rate.

| Indicator | Parameter | Weighing Speed | Stability | Display refresh rate |
|-----------|-----------|--|-----------------|---|
| FAST | Cond 0 | Fast response, ↑ Slow response, ↓ | Sensitive value | If the weighing speed is changed as follows: MID. or SLOW FAST = 10 times/second FAST MID. or SLOW = 5 times/second |
| MID. | Cond 1 | | Stable value | |
| SLOW | Cond 2 | | | |

Step 1 Press and hold the **MODE** key until **RESPONSE** is displayed. And then, press the **MODE** key again quickly.

Step 2 Press the **MODE** key to select a weighing speed. Either **FAST**, **MID.** or **SLOW** can be selected.

Step 3 After a few seconds of inactivity the balance displays **end**. Then, it returns to the weighing mode and displays the updated response indicator. The response indicator remains displayed for a while.

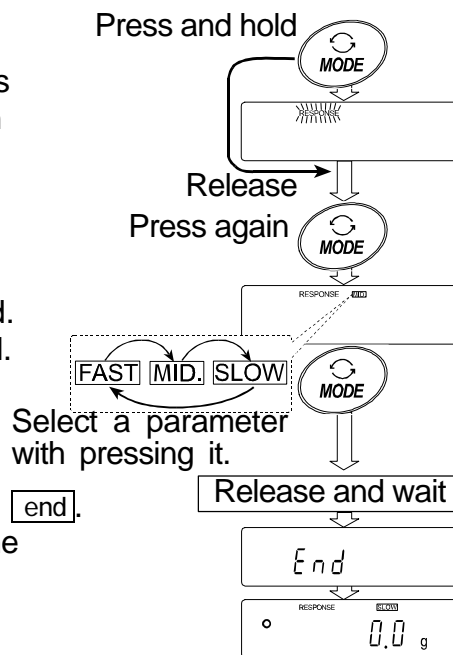

Note

- The weighing speed adjustment can be changed at "Condition (Cond)" of "Environment, Display (ba5fnc)" in the function table. Refer to "10. Function Table" for details.
- To set a refresh rate of 5 times/second when the response rate is **FAST** or 10 times/second when the response rate is **MID.** or **SLOW**, change the "Display refresh rate (5pd)" parameter of "Environment, Display (ba5fnc)" in the function table.

7-2. Self Check Function With Response Adjustment For The GX-K Series

This function automatically updates the response adjustment by analyzing the influence of the environment on the weighing data and also self-checks the balance performance using the internal mass.

Step 1 Press and hold the **[MODE]** key until **[RESPONSE]** is displayed, and then release the key.

Step 2 The balance automatically starts to check the balance performance and sets the response characteristic.

Caution Do not allow vibration or drafts to affect the balance during adjustment.

Step 3 After automatic adjustment, the balance displays the updated response indicator and returns to the weighing mode. The response indicator remains displayed for a while.

Example of display

[MID.] and **[OK]** : The example above indicates that the result of the self check is good and MID. is selected as the response rate..

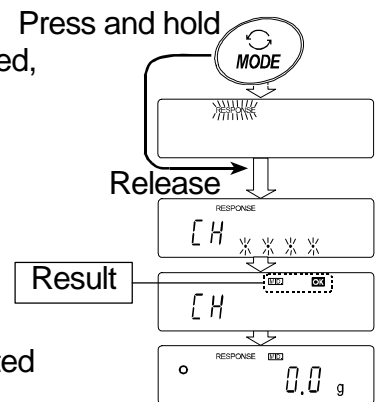

Note

- If improper performance is found in the self check, the balance displays **[CH no.]**. Contact the local A&D dealer for repair.
- If the automatic response adjustment fails, the balance displays **[CH ng.]**. Check the ambient conditions such as breeze and vibration, also check the weighing pan. Then, perform the adjustment again. To return to the weighing mode, press the **[CAL]** key.

Advise

If the automatic response adjustment is not helpful, try to refine it using the "7-3. Self Check Function For GF-K Series".

7-3. Self Check Function For GF-K Series

This function manually updates the response adjustment by analyzing the influence of the environment on the weighing data.

Step 1 Press and hold the **[MODE]** key until **[RESPONSE]** is displayed. And then, press the **[MODE]** key again quickly.

Step 2 Press the **[MODE]** key to select a weighing speed. Either **[FAST]**, **[MID.]** or **[SLOW]** can be selected.

Step 3 After a few seconds of inactivity the balance displays **[end.]**. Then, it returns to the weighing mode and displays the updated response indicator. The response indicator remains displayed for a while.

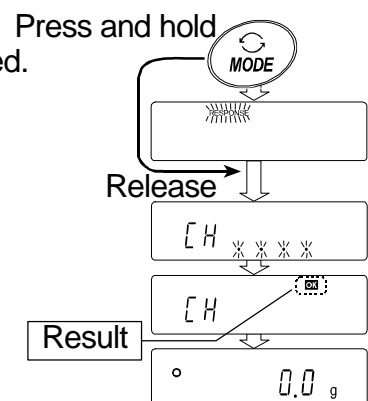

Note

- If improper performance is found in the self check, the balance displays **[CH no.]**. Contact the local A&D dealer for repair.

8. Calibration

8-1. Calibration Group

The balance has the following modes as a calibration group.

Calibration

- Automatic self calibration (Calibration due to changes in temperature for GX-K series)
- Calibration using the internal mass for GX-K series (One-touch calibration)
- Calibration using an external weight

Calibration Test

- Calibration test using an external weight (Calibration test does not perform calibration)

Correction of the internal mass value

Terms

The following terms are defined as follows:

- Internal mass = Built-in calibration weight (GX-K series only)
- External weight = A weight that you have. Referred to as a calibration weight when used for calibration.
- Calibration weight = A weight used for calibration
- Target weight = An external weight used for calibration test

Caution

- The GF-K series does not perform "automatic self calibration" and "one-touch calibration using the internal mass", as it does not include an internal mass.
- Calibration adjusts the balance for accurate weighing.
Besides periodic calibration and before each use, perform calibration when:
 - the balance is installed for the first time.
 - the balance has been moved.
 - the ambient environment has changed.
- Do not allow vibration or drafts to affect the balance during calibration.
- To output the data for GLP using the RS-232C interface, set "GLP output (info)" of "Data output (dout)". Refer to "10. Function Table". The time and date can be added to the GLP report concerning the GX-K series. If the time or date is not correct, adjust them. Refer to "10-7 Clock and Calendar Function".
- Calibration test is available only when "GLP output (info)" of "Data output (dout)" is set to "1" or "2",
- For GX-K series, the calibration and calibration test data can be stored in memory. To store them, set "Data memory (data)" to "3". Refer to "12. Data Memory" for details.
- For GF-K series, the calibration and calibration test data is not stored in memory.
- The value of the internal mass may change due to aging, corrosion or other damage caused by the operating environment. Check the internal mass periodically. Correct the internal mass value as necessary.

Caution On Using An External Weight

- The accuracy of an external weight can influence the accuracy of weighing. Select an appropriate weight as listed below:
- Select a mass for calibration and calibration test from the following table.

| Model | | Usable calibration weight | Adjustable range |
|------------------|------------------|---|------------------|
| GX-8K GX-8K2 | GF-8K GF-8K2 | 2kg, 3kg, 4kg, 5kg , 6kg, 7kg, 8kg | -0.15g ~ +0.15 g |
| GX-12K | GF-12K | 5kg, 10kg | |
| GX-20K | GF-20K | 10kg, 20kg | |
| GX-30K GX-32K | GF-30K GF-32K | 20kg , 30kg | |

The calibration weight in **bold type**: factory setting

The calibration weight value can be adjusted within the range above.

Display



This indicator means "In process of measuring calibration data". Do not allow vibration or drafts to affect the balance while the indicator is displayed.

8-2. Automatic Self Calibration For The GX-K Series

Automatic self calibration due to changes in temperature

This function automatically calibrates the balance when the balance detects an ambient temperature change. If GLP output is selected in the function table, the balance outputs the calibration report or stores the data in memory. Automatic self calibration functions even if the display is turned off (standby state). Refer to "9-1. Permit Or Inhibit" for the operation.

Caution

- **If something is on the weighing pan, the balance judges that it is in use and does not perform automatic self calibration. To maintain the calibrated state, keep the weighing pan clear while not in use.**
- **GF-K series can not use this calibration mode.**



Indicates that the balance detects a change in ambient temperature and automatic self calibration will start. If the balance is not used for a few minutes with this indicator blinking, the balance performs automatic self calibration. The blinking duration depends on the environment.

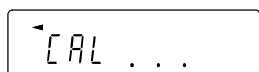

Indicates that the balance is measuring calibration data. Do not allow vibration or drafts to affect the balance while this indicator is displayed. After calibration, the balance returns to indicate the previous display.

Note The balance can be used while the indicator blinks. But, it is recommended that to maintain the accuracy, stop using the balance and confirm that there is nothing on the pan and allow the balance to perform self calibration.

8-3. One-Touch Calibration For The GX-K Series

Calibration using the internal mass for The GX-K series

This function calibrates the balance using the internal mass. The only operation required is to press the **CAL** key.

Caution

- **GF-K series can not use this calibration mode.**

- Step 1 Connect the AC adapter and warm up the balance for at least 30 minutes with nothing on the weighing pan.
- Step 2 Press the **CAL** key.
- Step 3 The balance displays **Calin** and performs calibration using the internal mass. Do not allow vibration or drafts to affect the balance.
- Step 4 The balance displays **end** after calibration. If the "GLP output (info)" parameter of the function table is set to "1" or "2", the balance displays **glp** and outputs the "calibration report" using the RS-232C interface or stores the data in memory. Refer to "11-2. GLP Report" and "Data memory (data)" of the function table for details.
- Step 5 The balance will automatically return to the weighing mode after calibration.

About the internal mass

The value of the internal mass may change due to aging, corrosion or other damage caused by the operating environment. Check the internal mass periodically. Correct the internal mass value as necessary. Refer to "8-6. Correcting the internal mass value".

To maintain the weighing accuracy, perform the calibration using an external weight periodically, as described below.

8-4. Calibration Using An External Weight

This function calibrates the balance using an external weight.

Step 1 Connect the AC adapter and warm up the balance for at least 30 minutes with nothing on the weighing pan.

Step 2 Press and hold the **[CAL]** key until **[Cal out]** is displayed, then release the key.

Step 3 The balance displays **[Cal 0]**.

- If you want to change the calibration weight, press the **[SAMPLE]** key and go to step 4.
- If you use the calibration weight value stored in the balance, go to step 5.

Step 4 Specify the calibration weight value as follows:

[SAMPLE] key... To switch the display condition to: "All of the segments blinking" (calibration weight selection mode) or "The last two digits blinking" (value adjustment mode).

[RE-ZERO] key.. To select the calibration weight or adjust the value. In the value adjustment mode, -15 digits appear after +15 digits.

[PRINT] key To store the new weight value. Even if the AC adapter is removed, the data is maintained in non-volatile memory.

[CAL] key To cancel the operation and return to **[Cal 0]**.

Step 5 Confirm that there is nothing on the pan and press the **[PRINT]** key. The balance measures the zero point. Do not allow vibration or drafts to affect the balance. The balance displays the calibration weight value.

Step 6 Place the displayed calibration weight on the pan and press the **[PRINT]** key. The balance measures the calibration weight. Do not allow vibration or drafts to affect the balance.

Step 7 The balance displays **[end]**.
Remove the weight from the pan.

Step 8 If the "GLP output (info)" parameter, of the function table, is set to "1" or "2", the balance displays **[glp]** and outputs "Calibration Report" using the RS-232C interface or stores the data in memory. For details on the calibration report format, refer to "11-2 GLP Report".

Step 9 The balance will automatically return to the weighing mode.

Step 10 Place the calibration weight on the pan and confirm that the value displayed is within ± 2 digits of the specified value. If it is not within the range, check the ambient conditions such as breeze and vibration also check the weighing pan. Then, repeat steps 1 to 10.

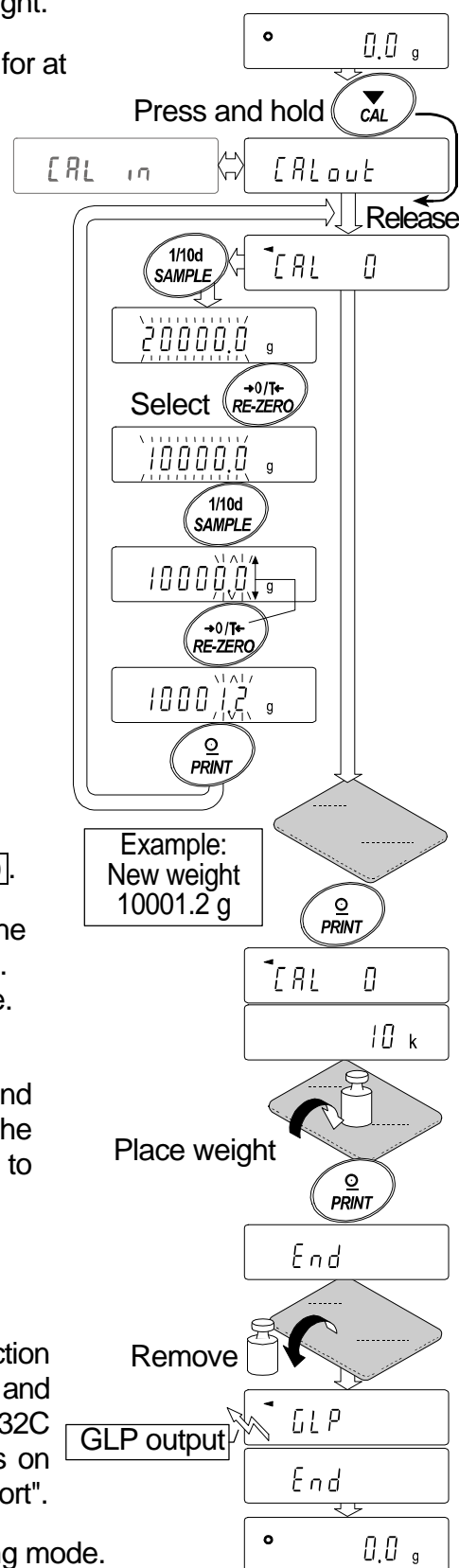

8-5. Calibration Test Using An External Weight

This function tests the weighing accuracy using an external weight and outputs the result. This is available only when the "GLP output (info)" parameter is set to "1" or "2". (Calibration test does not perform calibration)

- Step 1 Connect the AC adapter and warm up the balance for at least 30 minutes with nothing on the weighing pan.
- Step 2 Press and hold the **CAL** key until **CCout** is displayed, then release the key.
- Step 3 The balance displays **CC 0**.
- If you want to change the target weight, press the **SAMPLE** key and go to step 4. A list of usable weights is shown on page 24.
 - If you use the target weight value stored in the balance, go to step 5.
- Step 4 Specify the target weight value as follows:
- SAMPLE** key... To switch the display condition to: "All of the segments blinking" (target weight selection mode) or "The last two digits blinking" (value adjustment mode).
- RE-ZERO** key · To select the target weight or adjust the value. In the value adjustment mode, -15 digits appear after +15 digits.
- PRINT** key To store the new weight value. Even if the AC adapter is removed, the data is maintained in non-volatile memory.
- CAL** key To cancel the operation and return to **CC 0**.
- Step 5 Confirm that there is nothing on the pan and press the **PRINT** key. The balance measures the zero point and displays the measured value. Do not allow vibration or drafts to affect the balance. The balance displays the target weight value.
- Step 6 Place the displayed target weight on the pan and press the **PRINT** key. The balance measures the target weight and displays the measured value. Do not allow vibration or drafts to affect the balance.
- Step 7 The balance displays **end**. Remove the weight from the pan.
- Step 8 The balance displays **glp** and outputs "calibration test report" using the RS-232C interface or stores the calibration test data in memory. Refer to "11-2 GLP Report" of the function table for details.

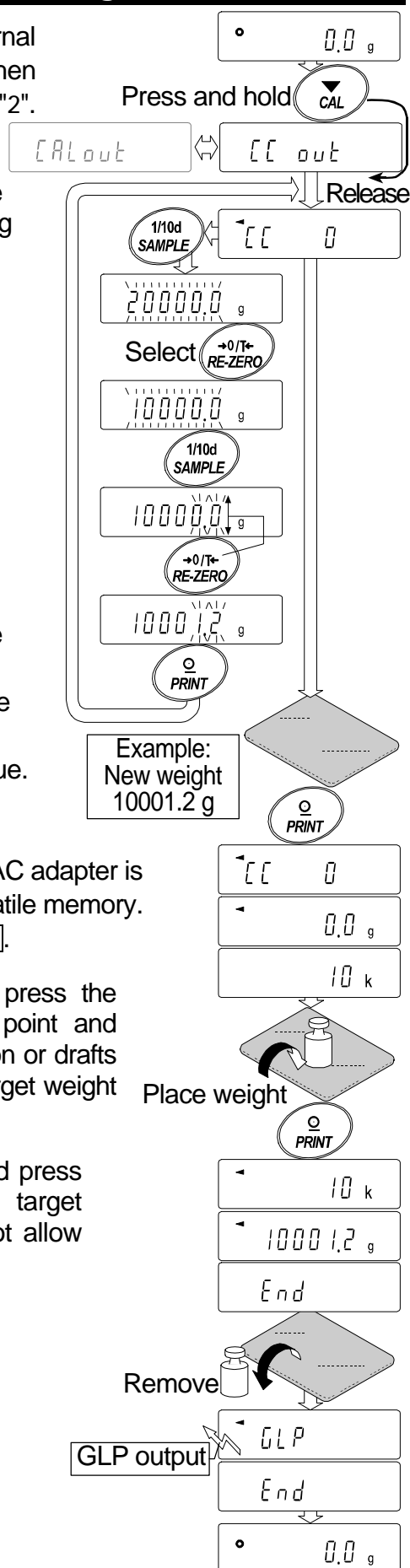

Step 9 The balance will automatically return to the weighing mode.

8-6. Correcting The Internal Mass Value Of The GX-K Series

The balance can correct the internal mass value within the range shown below. This function corrects the internal mass value to conform to an external weight. The corrected mass value is maintained in non-volatile memory even if the AC adapter is removed. The internal mass value is corrected as follows:

Note GF-K series can not use this function.

| Model | Target | Range |
|--------------------------------|--------|--------|
| GX-8K GX-8K2 | 2kg | ±0.50g |
| GX-12K GX-20K GX-30K GX-32K | 10kg | ±5.0g |

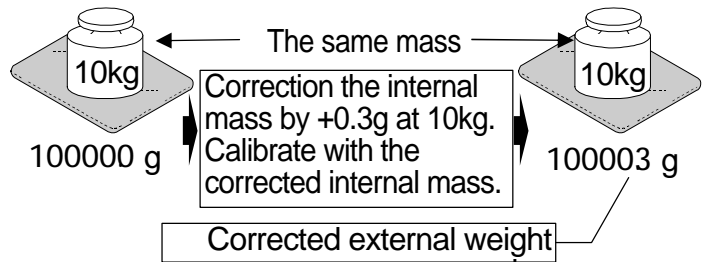

Step 1 Calibrate the balance using the internal mass. (one-touch calibration)
Then, place an external weight and confirm the value to be corrected. Example: The value is to be corrected by +0.3 gram in 10 kilogram.

Step 2 Press the **ON:OFF** key to turn off the display.

Step 3 While pressing and holding the **PRINT** key and the **SAMPLE** key, press the **ON:OFF** key. The balance displays **p5**.

Step 4 Press the **PRINT** key. Then the balance displays the function switches. Set the function table switch and internal mass correction switch to "1" as shown above using the following keys.
SAMPLE key... To select the switch to change the value.
The selected digit blinks.
RE-ZERO key .. To change the parameter of the switch selected.

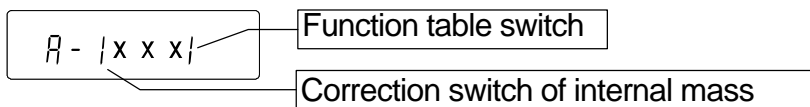

Step 5 Press the **PRINT** key to store the new setting. The balance returns to the weighing mode.

Step 6 Press and hold the **SAMPLE** key to enter the function table and release the key when **ba5fnc** is displayed.

Step 7 Press the **SAMPLE** key several times until **[5 in** is displayed, then release the key.

Step 8 Press the **PRINT** key to enter the procedure for correcting the internal mass value.

Step 9 Correct the internal mass value using the following keys.
RE-ZERO key .. To select the value. (-50 digits appear after +50 digits)

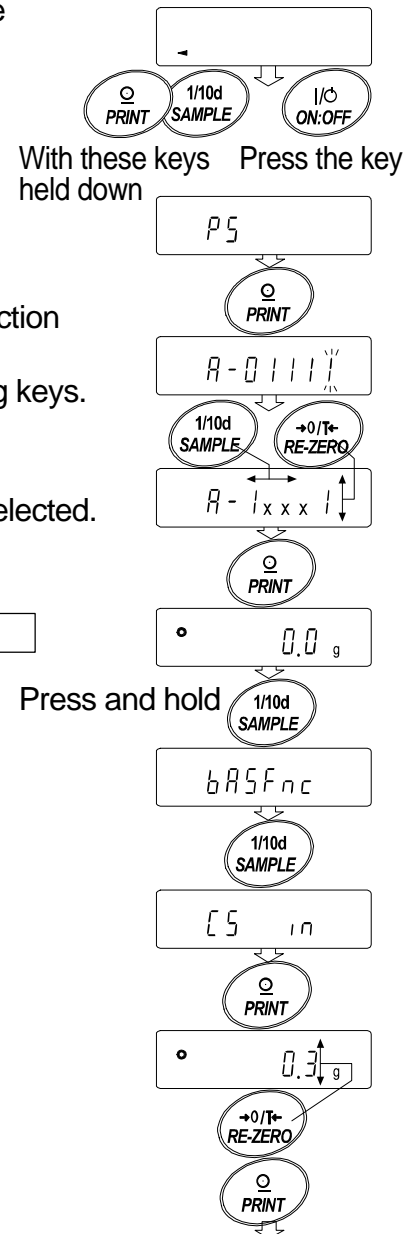

PRINT key.....To store the new value and display the next menu item of the function table.

CAL key.....To cancel the correction and display the next menu item of the function table.

Step 10 Press the **CAL** key to return the weighing mode.

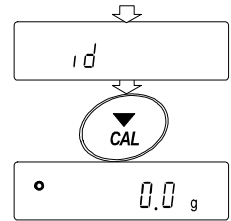

Step 11 Press the **CAL** key to calibrate the balance using the internal mass.

Step 12 Place the external weight on the pan and confirm that the correction has been performed properly. In this example, confirm that the value displayed is within the range that is described at "Accuracy after calibration using the internal mass" of "20. Specification ". If the value is incorrect, repeat the correction.

9. Function Switch And Initialization

9-1. Permit Or Inhibit

The balance stores parameters that must not be changed unintentionally (Example: Calibration data for accurate weighing, Data for adapting to the operating environment, Control data for the RS-232C interface). There are five switches for the purpose of protecting parameters. Each switch can select either "permit" or "inhibit". The "inhibit" protects parameters against unintentional operations.

Step 1 Press the **ON:OFF** key to turn off the display.

Step 2 While pressing and holding the **PRINT** key and the **SAMPLE** key, press the **ON:OFF** key to display **p5**.

Step 3 Press the **PRINT** key. Then the balance displays the function switches.

Step 4 Set the switches using the following keys.

| | |
|--------------------|--|
| SAMPLE key | To select a switch to change the parameter. The selected switch blinks. |
| RE-ZERO key | To change the parameter of the switch selected. 0 To inhibit changes. (Can not be used.) 1 To permit changes. (Can be used.) |
| PRINT key | To store the new parameter and return to the weighing mode. |
| CAL key | To cancel the operation and return to the weighing mode. |

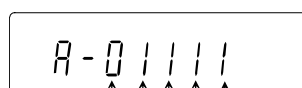

GX-K series. The display shown left indicates the factory settings.

Function table

- 0 To inhibit changes to the function table.
- 1 To permit changes to the function table.

Calibration using the internal mass (One-touch calibration)

- 0 To inhibit calibration using the internal mass.
- 1 To permit calibration using the internal mass.

Calibration using an external weight

- 0 To inhibit calibration using an external weight.
- 1 To permit calibration using an external weight.

Automatic self calibration (Calibration due to changes in temperature)

- 0 To inhibit automatic self calibration.
- 1 To permit automatic self calibration.

Internal mass correction

- 0 To inhibit correction
- 1 To permit correction

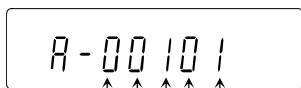

GF-K series. The display shown left indicates the factory settings.

Function table

- 0 To inhibit changes to the function table.
- 1 To permit changes to the function table.

Not used

Calibration using an external weight

- 0 To inhibit calibration using an external weight.
- 1 To permit calibration using an external weight.

Not used

9-2. Initializing The Balance

This function returns the following parameters to factory settings.

- Calibration data
- Function table
- The sample unit mass value (counting mode),
100% reference mass value (percent mode)
- The data that is stored in the balance using the data memory function
- External calibration weight and target weight value
- Function switch settings
- Liquid density and temperature in the density mode

Note Be sure to calibrate the balance after initialization.

Step 1 Press the **ON:OFF** key to turn off the display.

Step 2 While pressing and holding the **PRINT** key and the **SAMPLE** key, press the **ON:OFF** key to display **p5**.

Step 3 Press the **SAMPLE** key to display **[Clr]**.

Step 4 Press the **PRINT** key.
To cancel this operation, press the **CAL** key.

Step 5 Press the **RE-ZERO** key to display **[Clr go]**.

Step 6 Press the **PRINT** key to initialize the balance.
The balance will automatically return to the weighing mode.

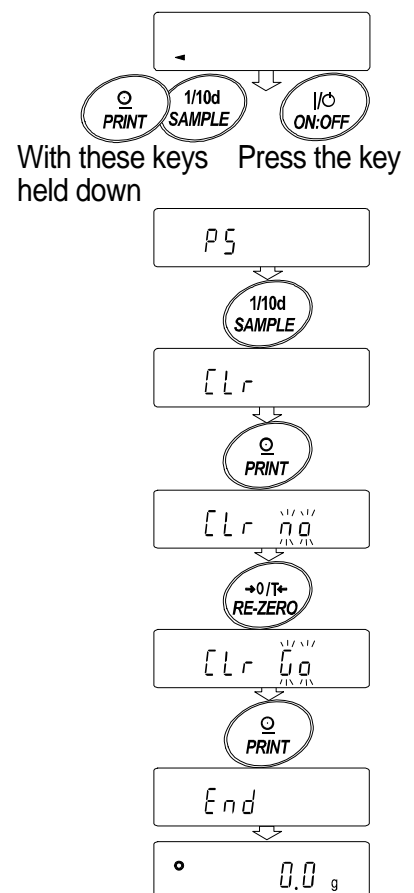

10. Function Table

This function table reads or rewrites the parameters that are stored in the balance. These parameters are maintained in non-volatile memory, even if the AC adapter is removed.

10-1-1. Structure And Sequence Of The Function Table

This function table menu consists of two layers. The first layer is the "Class" and the second layer is the "Item". It has effect that a parameter is stored in each item and is displayed latest. New parameters are applied to the balance after the **PRINT** key is pressed.

Example

This example sets "Stores weighing data" for "Data memory" and "1 minute" for "Interval time".

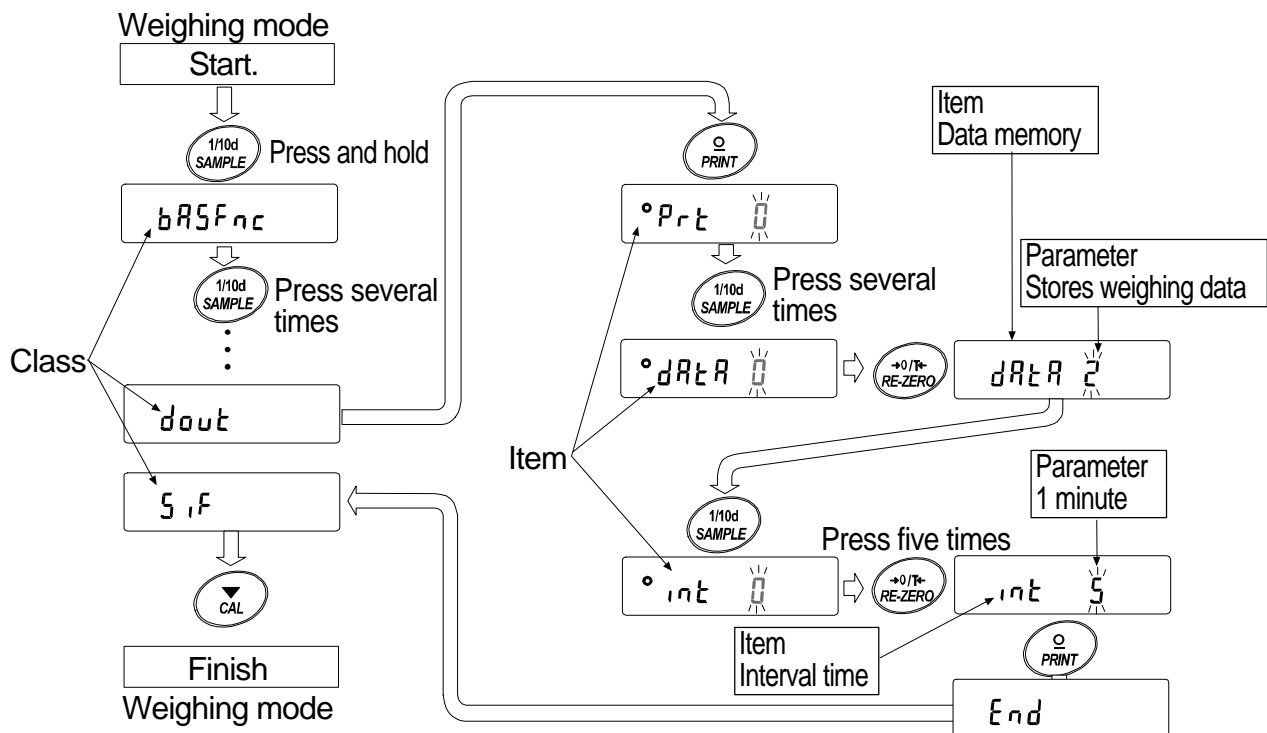

Caution

Check the settings and condition before changing parameters.

10-1-2. Display And Operation Keys

| | |
|--|--|
| | The symbol "O" shows effective parameter. |
| | When pressed and held in the weighing mode, enters the function table mode. Selects the class or item in the function table mode. |
| | Changes the parameter. |
| | When a class is displayed, moves to an item in the class. When an item is displayed, stores the new parameter and displays the next class. |



When an item is displayed, cancels the new parameter and displays the next class.
When a class is displayed, exits the function table mode and returns to the weighing mode.

10-2. Details Of The Function Table

| Class | Item and Parameter | Description | | |
|---|--|------------------|---|---|
| ba5fnc Environment Display | Cond Condition | 0 | Fast response, sensitive value FAST | |
| | | ▪ 1 | ↕ | |
| | | 2 | Slow response, stable value SLOW | |
| | | ▪ 1 | ↕ | |
| | 5t-b Stability band width | 0 | Stable when within ± 1 digit | |
| | | ▪ 1 | ↕ | |
| | Hol d Hold function | 0 | OFF | |
| | | ▪ 1 | ON | |
| | trc Zero tracking | 0 | OFF | |
| | | ▪ 1 | ON | |
| | 5pd Display refresh rate | 0 | 5 times/second | |
| | | ▪ 1 | 10 times/second | |
| | pnt Decimal point | 0 | Point (.) | |
| | | ▪ 1 | Comma (,) | |
| p-on Auto display-ON | 0 | OFF | | |
| | ▪ 1 | ON | | |
| poff Auto display-OFF | 0 | OFF | | |
| | ▪ 1 | ON (10 minutes) | | |
| g5i Capacity indicator | 0 | OFF | | |
| | ▪ 1 | ON | | |
| add Accumulation function | 0 | OFF | | |
| | ▪ 1 | ON | | |
| rng Display at start | 0 | Does not display | | |
| | ▪ 1 | Displays | | |
| Cl adj Clock ☆ | Refer to "10-7. Clock and Calendar Function" | | Confirms and sets the time and date. The time and date are added to the output data. | |
| Cp fnc Comparator | Cp Comparator mode | 0 | No comparison | |
| | | 1 | Comparison, excluding "near zero" when stable value or overloaded | |
| | | 2 | Comparison, including "near zero" when stable value or overloaded | |
| | | 3 | Continuous comparison, excluding "near zero" | |
| | | 4 | Continuous comparison, including "near zero" | |
| | Cp i n Data input method | 0 | Set the upper lower limit value | Select Cp Hi or Cp Lo. |
| | | ▪ 1 | Set the reference value | Select Cp ref or Cp lmt. |
| | Cp-r Comparison results | 0 | Not added | Select whether or not to add the comparison results to the output data. |
| | | ▪ 1 | Added | |
| | Cp-b Main display comparison | 0 | OFF | Displays the results on the main portion of the display in place of the weight value. |
| ▪ 1 | | ON | | |
| Displayed only when Comparator output (GX-04K) is installed | bep- LO buzzer | 0 | OFF | |
| | | ▪ 1 | ON | |
| | bep- OK buzzer | 0 | OFF | Select whether or not to sound the OK buzzer. |
| ▪ 1 | | ON | | |
| bep- HI buzzer | 0 | OFF | Select whether or not to sound the HI buzzer. | |
| | ▪ 1 | ON | | |

☆ : Functions for GX-K series. ▪ : Factory settings. Digit is a unit of minimum weighing value.

| Class | Item and Parameter | | Description | |
|---------------------------|-------------------------------|---------------|--|---|
| Cp Hi Upper limit | Cp I o Lower limit | | Refer to "10-8. Comparator Function" | Displayed when Cp i n 0 is selected. |
| Cp I o Lower limit | | | | |
| Cp ref Reference value | Cp I mt Tolerance | | Refer to "10-8. Comparator Function" | Displayed when Cp i n 1 is selected. |
| Cp I mt Tolerance | | | | |
| dout Data output | prt Data output mode | ▪ 0 | Key mode | Accepts the PRINT key only when the display is stable. |
| | | 1 | Auto print mode A (Reference = zero) | Outputs data when the display is stable and conditions of ap-p, ap-b and the reference value are met. |
| | | 2 | Auto print mode B (Reference = last stable value) | |
| | | 3 | Stream mode / Interval memory mode | With data 0, outputs data continuously; with data 2, uses interval memory. |
| | ap-p Auto print polarity | ▪ 0 | Plus only | Displayed value>Reference |
| | | 1 | Minus only | Displayed value<Reference |
| | | 2 | Both | Regardless of displayed value |
| | ap-b Auto print difference | ▪ 0 | 10 digits | Difference between reference value and displayed value |
| | | 1 | 100 digits | |
| | | 2 | 1000 digits | |
| | data Data memory | ▪ 0 | Not used | Related items: prt, i nt, d-no, 5-td, i nfo |
| | | 1 | Stores unit mass in counting mode | |
| | | 2 | Stores weighing data | |
| | | ☆ 3 | Stores calibration data | |
| | | 4 | Stores comparator settings | |
| | | 5 | Stores tare value | |
| | i nt Interval time | ▪ 0 | Every measurement | Interval time in the interval memory mode when using prt 3, data 2 |
| | | 1 | 2 seconds | |
| | | 2 | 5 seconds | |
| | | 3 | 10 seconds | |
| | | 4 | 30 seconds | |
| | | 5 | 1 minute | |
| | | 6 | 2 minute | |
| | | 7 | 5 minute | |
| | | 8 | 10 minute | |
| | d-no Data number output | ▪ 0 | No output | Refer to "12. DATA MEMORY" |
| | | 1 | Output | |
| | 5-td ☆ Time/Date output | ▪ 0 | No output | Selects whether or not the time or date is added to the weighing data. Refer to "10-7. Clock and Calendar Function" for details. |
| 1 | | Time only | | |
| 2 | | Date only | | |
| 3 | | Time and date | | |
| 5-i d ID number output | ▪ 0 | No output | Selects whether or not the ID number is output. | |
| | 1 | Output | | |

☆ : Functions for GX-K series. ▪ : Factory settings. Digit is a unit of minimum weighing value.

| Class | Item and Parameter | Description | | |
|--|--------------------------------|---|---|--|
| dout Data output | pU5e Data output pause | ▪ 0 | No pause | Selects the data output interval. |
| | | 1 | Pause (1.6 seconds) | |
| | at-f Auto feed | ▪ 0 | Not used | Selects whether or not automatic feed is performed. |
| | | 1 | Used | |
| | info GLP output | ▪ 0 | No output | Selects GLP output method. For how to set time and date to be added, refer to "10-7. Clock and Calendar Function". |
| | | 1 | AD-8121 format | |
| | | 2 | General data format | |
| | ar-d Zero after output | ▪ 0 | Not used | Adjusts zero automatically after data is output |
| 1 | | Used | | |
| 5i f Serial interface | bp5 Baud rate | 0 | 600 bps | |
| | | 1 | 1200 bps | |
| | | ▪ 2 | 2400 bps | |
| | | 3 | 4800 bps | |
| | | 4 | 9600 bps | |
| | | 5 | 19200 bps | |
| | btpr Data bit, parity bit | ▪ 0 | 7 bits, even | |
| | | 1 | 7 bits, odd | |
| | | 2 | 8 bits, none | |
| | Cr l f Terminator | ▪ 0 | CR LF | CR: ASCII code 0Dh LF: ASCII code 0Ah |
| | | 1 | CR | |
| | type Data format | ▪ 0 | A&D standard format | Refer to "10-5. Description of Item "Data Format". |
| | | 1 | DP format | |
| | | 2 | KF format | |
| 3 | | MT format | | |
| 4 | | NU format | | |
| t-Up Timeout | 0 | No limit | Selects the wait time to receive a command. | |
| | ▪ 1 | 1 second | | |
| erCd AK, Error code | ▪ 0 | No output | AK: ASCII code 06h | |
| | 1 | Output | | |
| Ct5 CTS, RTS control | ▪ 0 | Not used | Controls CTS and RTS. | |
| | 1 | Used | | |
| d5 fnc Density function | l di n Liquid density input | ▪ 0 | Water temperature | Available only when density mode is selected |
| | | 1 | Liquid density | |
| ml t Programmable-unit (Multi-unit) | | Available only when programmable-unit mode is selected. Refer to "13. Programmable Units" for details". | | |
| Uni t Unit | | Refer to "5. Weighing Units". | | |
| C5 i n ☆ Internal mass correction | | Displayed only when the internal mass value correction switch is set to 1. Refer to "8. Calibration". | | |
| i d ID number setting | | Refer to "11. ID Number And GLP Report". | | |

☆ : Functions for GX-K series. ▪ : Factory settings. Digit is a unit of minimum weighing value.

Caution

The balance may not transmit the data completely at the specified refresh rate, depending on the baud rate or data added to the weighing data such as time, date and ID number.

10-3. Description Of The Class "Environment, Display"

Condition (Cond)

Cond 0 This parameter is for sensitive response to the fluctuation of a weight value. Used for powder target weighing, weighing a very light sample or when quick response weighing is required. After setting, the balance displays **FAST**.



Cond 2 This parameter is for stable weighing with slow response. Used to prevent a weight value from drifting due to vibration or drafts. After setting, the balance displays **SLOW**.

Notes In automatic response adjustment, the weighing speed is selected automatically.

With "Hold function (Hol d)" set to "ON (1)", this item is used to set the averaging time.

Stability band width (5t-b)

This item controls the width to regard a weight value as a stable value. When the fluctuation per second is less than the parameter, the balance displays the stabilization indicator and outputs or stores the data. The parameter influences the "Auto print mode"

5t-b 0 This parameter is used for sensitive response of the stabilization indicator. Used for exact weighing.



5t-b 2 This parameter ignores slight fluctuation of a weight value. Used to prevent a weight value from drifting due to vibration or drafts.

Note With "Hold function (Hol d)" set to "ON (1)", this item is used to set the stabilization range.

Hold function (Hol d) (Animal weighing mode)

This function is used to weigh a moving object such as an animal. When the weighing data is over the weighing range from zero and the display fluctuation is within the stabilization range for a fixed period of averaging time, the processing indicator illuminates and the balance displays the average weight of the animal. When the animal is removed from the weighing pan, the display returns to zero automatically. This function is available only when the hold function parameter is set to "1" (the animal mode indicator **ANIMAL** illuminates) and any weighing unit other than the counting mode is selected. The stabilization range and averaging time are set in "Condition (Cond)" and "Stability band width (5t-b)".

| Weighing range | | |
|----------------|--------|-----|
| GX-8K | GX-8K2 | 2g |
| GF-8K | GF-8K2 | |
| GX-12K | GX-20K | 20g |
| GX-30K | GX-32K | |
| GF-12K | GF-20K | |
| GF-30K | GF-32K | |

| Averaging time | | |
|----------------|--------|---------------|
| Cond 0 | 2 sec. | Faster |
| Cond 1 | 4 sec. | ↕ |
| Cond 2 | 8 sec. | More accurate |

| Stable range | | |
|--------------|--|-------|
| 5t-b 0 | | Small |
| 5t-b 1 | | ↕ |
| 5t-b 2 | | Big |

Zero tracking (trc)

This function tracks zero point drift caused by changes in the environment and stabilizes the zero point. When the weighing data is only a few digits, turn the function off for accurate weighing.

trc 0 The tracking function is not used. Used for weighing a very light sample.



trc 1 The tracking function is used. Used for stable zero display.

Display refresh rate (5pd)

Period to refresh the display. This parameter influences "Baud rate", "Data output pause" and "Stream mode".

Note This item is selected automatically in the weighing speed adjustment.

Decimal point (pnt)

The decimal point format can be selected.

Auto display-ON (p-on)

When the AC adapter is plugged in, the display is automatically turned on without the ON:OFF key operation, to display the weighing mode. Used when the balance is built into an automated system. 30 minutes warm up is necessary for accurate weighing.

Auto display-OFF (poff)

When the AC adapter is connected and no operation is performed (inactivity state) for 10 minutes, the display is automatically turned off and the standby indicator illuminates.

Capacity indicator (g5i)

In the weighing mode, the indicator displays the weighing data relative to the weighing capacity in percentage. (Zero = 0%, maximum capacity = 100%)

When the "Data memory (data)" parameter is set to "1" (to store unit mass in the counting mode), "2" (to store the weighing data), "4" (to store comparator settings) or "5" (to store tare value), the indicator displays the information stored in memory, such as the amount of memory data or data number.

Accumulation function (add)

The accumulation function adds the weighing data, displays and outputs the total value. Refer to "6-5. Accumulation Function." for details.

Display at start (rng)

When the weighing accuracy is not so strict, the smallest displayable weighing value can be turned off without any key operation at weighing start. Useful when the balance is built into an automated system.

10-4. Description Of The Item "Data Output Mode"

The parameter setting of "Data output mode (prt)" applies to the performance when the "Data memory (data)" parameter is set to "2" (to store the weighing data) and when the data is transmitted using the RS-232C interface.

Key mode

When the key is pressed with the stabilization indicator turned on, the balance outputs or stores the weighing data and the display blinks one time.

Required setting dout prt 0 Key mode

Auto print modes A and B

When the displayed value is stable and the conditions of "Auto print polarity", "Auto print difference" and reference value are met, the balance outputs or stores the weighing data.

When the key is pressed with the stabilization indicator turned on, the balance outputs or stores the data and the display blinks one time.

Auto print modes A

Example For weighing each time a sample is placed and removed, with "ar-d" set to "1" (to adjust zero after the data is output).

Required setting dout prt 1 Auto print mode A (reference = zero)
 dout ap-p Auto print polarity
 dout ap-b Auto print difference
 dout ar-d 1 Zero after output

Auto print modes B

Example For weighing while a sample is added.

Required setting dout prt 2 Auto print mode B (reference = last stable value)
 dout ap-p Auto print polarity
 dout ap-b Auto print difference

Stream mode

The balance outputs the weighing data continuously regardless of the display condition. The display does not blink in this mode. The interval memory mode is used when the "Data memory (data)" parameter is set to "2" (to store the weighing data).

Example For monitoring data on a computer.

Required setting dout prt 3 Stream mode
 dout data 0 Data memory function is not used
 ba5fnc 5pd Display refresh rate
 5i f bp5 Baud rate

Caution The balance may not transmit the data completely at the specified refresh rate, depending on the baud rate or data added to the weighing data such as time, date and ID number.

Interval memory mode

The weighing data is periodically stored in memory.

| | | | |
|------------------|--|------------------------------|--|
| Example | For periodical weighing without a personal computer command and to output all of the data, to a computer, at one time. | | |
| | The GX-K series can use time and date with "Time/Date output (5-td)". | | |
| Required setting | dout prt 3 | Interval memory mode | |
| | dout data 2 | Data memory function is used | |
| | dout int | Interval time | |
| Optional setting | dout 5-td1, 2, or 3 | Adds the time and date. | |

10-5. Description Of The Item "Data Format"

A&D standard format 5i f type 0

This format is used when the peripheral equipment can receive the A&D format.

If an AD-8121B is used, set the printer to MODE 1 or 2.

- This format consists of fifteen characters excluding the terminator.
- A header of two characters indicates the balance condition.
- The polarity sign is placed before the data with the leading zeros. If the data is zero, the plus sign is applied.
- The unit, consisting of three characters, follows the data.

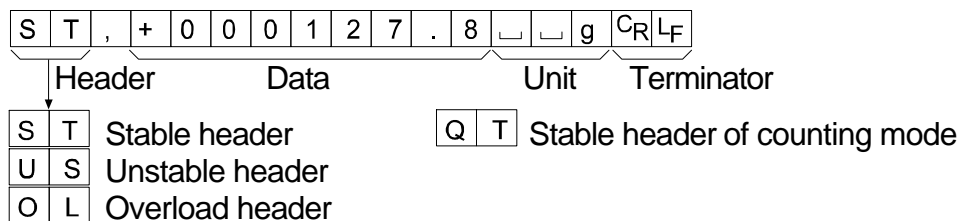

DP (Dump print) format 5i f type 1

This format is used when the peripheral equipment can not receive the A&D format.

If an AD-8121B is used, set the printer to MODE 3.

- This format consists of sixteen characters excluding the terminator.
- A header of two characters indicates the balance condition. No overload header is used.
- The polarity sign is placed before the data, with spaces in place of leading zeros, if the data is not zero or overloaded.
- The unit, consisting of three characters, follows the data.

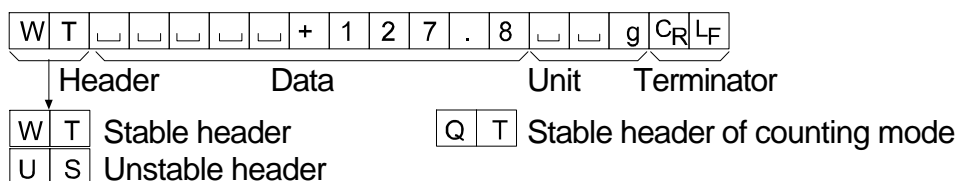

KF format

5i f type 2

This is the Karl-Fischer moisture meter format and is used when the peripheral equipment can only communicate using this format.

- This format consists of fourteen characters excluding the terminator.
- This format has no header characters.
- The polarity sign is placed before the data, with spaces in place of leading zeros, if the data is not zero or overloaded.
- This format outputs the unit only for a stable value.

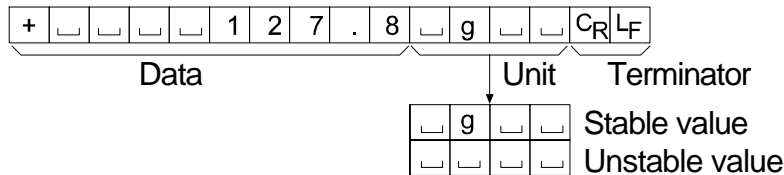

MT format

5i f type 3

- A header of two characters indicates the balance condition.
- The polarity sign is used only for negative data.
- The weighing data uses spaces in place of the leading zeros.
- The character length of this format changes dependent upon the unit

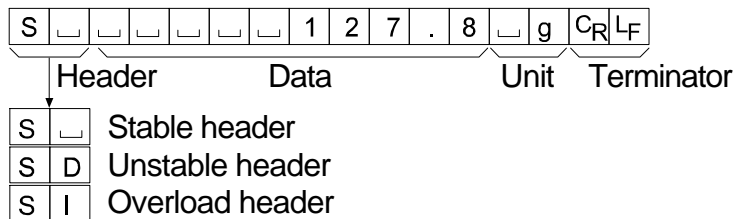

NU (numerical) format 5i f type 4

This format outputs only numerical data.

- This format consists of nine characters excluding the terminator.
- The polarity sign is placed before the data with the leading zeros. If the data is zero, the plus sign is used.

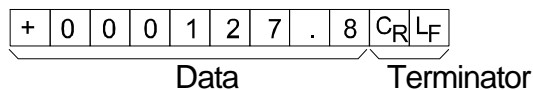

CSV format

5i f type 5

- This format separates the data of A&D standard format and the unit by a comma (,).
- This format outputs the unit even when the data is overloaded.
- When the ID number, data number, time and date are added at "Data output (dout)" of the function table, outputs ID number, data number, date, time and weighing data in this order and separates each item by a comma and treats all the items as one group of data.

Note GF-K series can not append date and time.

LAB-123, No,012, 2001/12/31, 12:34:56, ST,+000127.8, _ _ g <CR><LF>

ID number
Data number
Date
Time
Weighing data

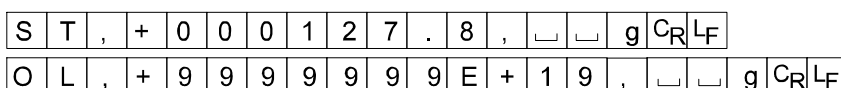

10-5-1. Description of the Data Format Added to the Weighing Data

ID number **dout 5-id 1**

The number to identify a specific balance.

- This format consists of seven characters excluding the terminator.

| | | | | | | | | |
|---|---|---|---|---|---|---|----------------|----------------|
| L | A | B | - | 1 | 2 | 3 | C _R | L _F |
|---|---|---|---|---|---|---|----------------|----------------|

Data number **dout d-no 1**

This format outputs the data number just before the data is transmitted using the RS-232C interface.

- This format consists of six characters excluding the terminator.
- When CSV format (5i f type 5) is selected, the period (.) is replaced with a comma (,).

| | | | | | | | |
|---|---|---|---|---|---|----------------|----------------|
| N | o | . | 0 | 0 | 1 | C _R | L _F |
|---|---|---|---|---|---|----------------|----------------|

Data number
Terminator

Date **dout 5-td 2 or 3**

- The date output order can be changed in "Clock (Cl adj)".
The year is output in a four-digit format.

| | | | | | | | | | | | |
|---|---|---|---|---|---|---|---|---|---|----------------|----------------|
| 2 | 0 | 0 | 4 | / | 1 | 2 | / | 3 | 1 | C _R | L _F |
|---|---|---|---|---|---|---|---|---|---|----------------|----------------|

Note GF-K series does not use this format.

Time **dout 5-td 1 or 3**

- This format outputs time in 24-hour format.

| | | | | | | | | | |
|---|---|---|---|---|---|---|---|----------------|----------------|
| 1 | 2 | : | 3 | 4 | : | 5 | 6 | C _R | L _F |
|---|---|---|---|---|---|---|---|----------------|----------------|

Note GF-K series does not use this format.

Tare value

- When the tare value in memory is recalled, the tare value is output before the weighing data.

| | | | | | | | | | | | | | | | | |
|---|---|---|---|---|---|---|---|---|---|---|---|---|---|---|----------------|----------------|
| P | T | , | + | 0 | 0 | 0 | 1 | 2 | 3 | . | 4 | □ | □ | g | C _R | L _F |
|---|---|---|---|---|---|---|---|---|---|---|---|---|---|---|----------------|----------------|

Tare value recalled from memory

| | | | | | | | | | | | | | | | | |
|---|---|---|---|---|---|---|---|---|---|---|---|---|---|---|----------------|----------------|
| N | □ | , | + | 0 | 0 | 0 | 5 | 6 | 7 | . | 8 | □ | □ | g | C _R | L _F |
|---|---|---|---|---|---|---|---|---|---|---|---|---|---|---|----------------|----------------|

Net value

Comparison results

- By setting "Comparison results (Cp-r)" of the function table to "1", the comparison results can be added to the data output using the RS-232C serial interface. Use A&D standard format (type 0).

The comparison results are added after the header in A&D standard format as below.

| | | | | | | | | | | | | | | | | | | | |
|---|---|---|---|---|---|---|---|---|---|---|---|---|---|---|---|---|---|----------------|----------------|
| S | T | , | O | K | , | + | 0 | 1 | 2 | 3 | 4 | 5 | . | 6 | □ | □ | g | C _R | L _F |
|---|---|---|---|---|---|---|---|---|---|---|---|---|---|---|---|---|---|----------------|----------------|

Header
Data
Unit
Terminator

↓ Comparison result

| | | |
|---|---|----------------------------------|
| H | I | When the comparison result is HI |
| O | K | When the comparison result is OK |
| L | O | When the comparison result is LO |
| - | - | Not applicable |

Note

When the data described above is added to the weighing data, the output is in the following order: ID number, Data number, Date, Time and Weighing data.

10-6. Data Format Examples

Stable

◦ 12.7 g

| | | | | | | | | | | | | | | | | | |
|-----|---|---|---|---|---|---|---|---|---|---|---|---|--|--|---|----|----|
| A&D | S | T | , | + | 0 | 0 | 0 | 0 | 1 | 2 | . | 7 | | | g | CR | LF |
| DP | W | T | | | | | | | | | | | | | | | |
| KF | + | | | | | | | | 1 | 2 | . | 7 | | | g | | |
| MT | S | | | | | | | | | | | | | | | | |
| NU | + | 0 | 0 | 0 | 0 | 1 | 2 | . | 7 | | | | | | | | |

Unstable

- 1836.9 g

| | | | | | | | | | | | | | | | | | |
|-----|---|---|---|---|---|---|---|---|---|---|---|---|--|--|---|----|----|
| A&D | U | S | , | - | 0 | 0 | 1 | 8 | 3 | 6 | . | 9 | | | g | CR | LF |
| DP | U | S | | | | | | | | | | | | | | | |
| KF | - | | | | | | | | | | | | | | | | |
| MT | S | D | | | | | | | | | | | | | | | |
| NU | - | 0 | 0 | 1 | 8 | 3 | 6 | . | 9 | | | | | | | | |

Overload

Positive error

E g

| | | | | | | | | | | | | | | | | | |
|-----|---|---|---|---|---|---|---|---|---|---|---|---|---|---|---|----|----|
| A&D | O | L | , | + | 9 | 9 | 9 | 9 | 9 | 9 | 9 | E | + | 1 | 9 | CR | LF |
| DP | | | | | | | | | | | | | | | | | |
| KF | | | | | | | | | | | | | | | | | |
| MT | S | I | + | | | | | | | | | | | | | | |
| NU | + | 9 | 9 | 9 | 9 | 9 | 9 | 9 | 9 | 9 | | | | | | | |

Overload

Negative error

- E g

| | | | | | | | | | | | | | | | | | |
|-----|---|---|---|---|---|---|---|---|---|---|---|---|---|---|---|----|----|
| A&D | O | L | , | - | 9 | 9 | 9 | 9 | 9 | 9 | 9 | E | + | 1 | 9 | CR | LF |
| DP | | | | | | | | | | | | | | | | | |
| KF | | | | | | | | | | | | | | | | | |
| MT | S | I | - | | | | | | | | | | | | | | |
| NU | - | 9 | 9 | 9 | 9 | 9 | 9 | 9 | 9 | 9 | | | | | | | |

- Space, ASCII 20h
- CR Carriage Return, ASCII 0Dh
- LF Line Feed, ASCII 0Ah

Units

| | | A&D | D.P. | KF | MT |
|------------------------------|--------------|------|------|--------|-------|
| g | g | □□g | □□g | □g□□ | □g |
| kg | kg | □kg | □kg | □kg□ | □kg |
| Counting mode | pcs | □PC | □PC | □pc s | □PC S |
| Percent mode | % | □□% | □□% | □%□□ | □% |
| Ounce (Avoir) | oz | □oz | □oz | □oz□ | □oz |
| Pound | lb | □lb | □lb | □lb□ | □lb |
| Pound Ounce | lb oz | □oz | □oz | □oz□ | □oz |
| Troy Ounce | oz t | oz t | oz t | □oz t | □oz t |
| Metric Carat | ct | □ct | □ct | □ct□ | □ct |
| Momme | mom | mom | mom | □mom | □mo |
| Pennyweight | dwt | dwt | dwt | □dwt | □dwt |
| Grain | GN | □GN | □GN | □gr□ | □GN |
| Tael (HK general, Singapore) | TL | □tl | □tl | □tl s | □tl |
| Tael (HK, jewelry) | TL | □tl | □tl | □tl h | □tl |
| Tael (Taiwan) | TL | □tl | □tl | □tl t | □tl |
| Tael (China) | TL | □tl | □tl | □tl c | □tl |
| Tola (India) | t | □□t | □□t | □t o l | □t |
| Messghal | MS | mes | mes | □MS□ | □m |
| Density | DS | □DS | □DS | □DS□ | □DS |
| Multi | (Blank) | □□□ | □□□ | □□□□ | □ |

□ Space, ASCII 20h

Note

When "Pound Ounce" is selected, the data is output with the unit of ounce (oz).
The unit Grain is not available for the GX-32K and GF-32K.

10-7. Clock And Calendar Function

The GX-K series is equipped with a clock and calendar function. When the "GLP output (info)" parameter is set to "1" or "2" and the "Time/Date output (5-td)" parameter is set to "1", "2" or "3", the time and date are added to the output data. Set or confirm the time and date as follows:

Note GF-K series does not use this function.

Operation

Step 1 Press and hold the **[SAMPLE]** key until **[ba5fnc]** of the function table is displayed in the weighing mode, then release the key.

Step 2 Press the **[SAMPLE]** key several times to display **[Cl adj]**.

Step 3 Press the **[PRINT]** key.
The balance enters the mode to confirm or set the time and date.

Confirming the time

- Step 4 The current time is displayed with all the digits blinking.
- When the time is correct and the date does not need to be confirmed, press the **[CAL]** key and go to step 8.
 - When the time is correct and the date is to be confirmed, press the **[SAMPLE]** key and go to step 6.
 - When the time is not correct and is to be changed, press the **[RE-ZERO]** key and go to step 5.

Setting the time (with part of the digits blinking)

- Step 5 Set the time in 24-hour format using the following keys.
- [SAMPLE]** key.....To select the digits to change the value.
The selected digits blink.
 - [RE-ZERO]** key.....To increase the value by one.
 - [MODE]** key.....To decrease the value by one.
 - [PRINT]** key.....To store the new setting, display **[end]** and go to step 6.
 - [CAL]** key.....To cancel the new setting and go to step 6.

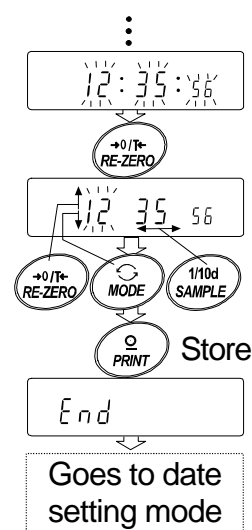

Confirming the date

- Step 6 The current date is displayed with all the digits blinking.
- To change the display order of year (y), month (m) and day (d), press the **[MODE]** key. The date is output in the order as specified.
 - When the date is correct and the operation is to be finished, press the **[CAL]** key and go to step 8.
 - When the time is to be confirmed again, press the **[SAMPLE]** key and go back to step 4.
 - When the date is not correct and is to be changed, press the **[RE-ZERO]** key and go to step 7.

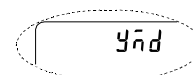

Note The year is expressed using a two-digit format.
For example: The year 2004 is expressed as "04".

Setting the date (with part of the digits blinking)

Step 7 Set the date using the following keys.

SAMPLE key.....To select the digits to change the value.
The selected digits blink.

RE-ZERO key.....To increase the value by one.

MODE key.....To decrease the value by one.

PRINT key.....To store the new setting, display **end** and go to step 8.

CAL key.....To cancel the new setting and go to step 8.

Quitting the operation

Step 8 The balance displays the next menu item of the function table. Press the **CAL** key to exit the clock and calendar function and return to the weighing mode.

Note Do not enter invalid values such as a non-existing date when setting the time and date.

When the clock backup battery has been depleted, the balance displays **rtc pf**. Under this condition, press any key and set the time and date. The dead battery only affects the clock and calendar function. Even so, the function works normally as long as the AC adapter is connected to the balance.

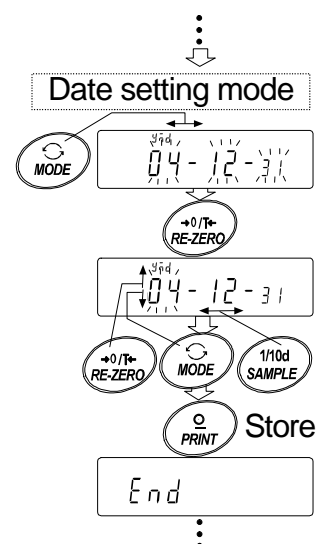

10-8. Comparator Function

The results of the comparison are indicated by **HI**, **OK** or **LO** on the display.

Operating conditions:

- No comparison
- Comparison when the weighing data is stable or overloaded, excluding "near zero"
- Comparison when the weighing data is stable or overloaded, including "near zero"
- Continuous comparison, excluding "near zero"
- Continuous comparison, including "near zero"

To compare, use:

- Upper limit value and lower limit value
- Reference value and tolerance value

Input method:

- Digital input
- Weighing input

For a description of "Comparator mode (Cp fnc)", refer to "10-2. Details of the Function Table".

"near zero" means that weighing value is within ± 10 digits from zero point.

Example: In case of GX-20K, the range of $\pm 1.0g$ is "near zero".

10-8-1. Example 1

Comparison when the weighing data is stable or overloaded, excluding "near zero", upper limit and lower limit.

Selecting a comparator mode

- Step 1 Press and hold the **[SAMPLE]** key until **[ba5fnc]** of the function table is displayed, then release the key.
- Step 2 Press the **[SAMPLE]** key several times to display **[Cp fnc]**.
- Step 3 Press the **[PRINT]** key.
- Step 4 Press the **[RE-ZERO]** key several times to display **[Cp 1]**.
- Step 5 Press the **[SAMPLE]** key to display **[Cp in]**.
- Step 6 Press the **[RE-ZERO]** key several times to display **[Cp in 0]**.
- Step 7 Press the **[PRINT]** key to store the selected mode.

Entering the upper and lower limit values

- Step 8 With **[Cp Hi]** displayed, press the **[PRINT]** key. The current setting of the upper limit value is displayed with all of the digits blinking.
- When the current setting is not to be changed, press the **[PRINT]** or **[CAL]** key to go to step 9.
 - When the current setting is to be changed, press the **[RE-ZERO]** key. The balance is now in the digital input mode. To use the weighing input mode, press and hold the **[MODE]** key.

Digital input mode

Change the setting using the following keys.

- [SAMPLE]** key ... To select the digit to change the value.
- [RE-ZERO]** key ... To change the value of the digit selected.
- [MODE]** key ... To switch the polarity.
- [PRINT]** key ... To store the new setting and go to step 9.
- [CAL]** key ... To cancel the new setting and go to step 9.

Weighing input mode

Press the **[RE-ZERO]** key. The balance displays **[00g]**. Place a sample, with a mass that corresponds to the upper limit value, on the pan. Press the **[PRINT]** key to store the upper limit value. Remove the sample. The balance displays **[Cp 1o]**.

- Step 9 With **[Cp 1o]** displayed, press the **[PRINT]** key. The current setting of the lower limit value is displayed with all of the digits blinking.
- When the current setting is not to be changed, press the **[PRINT]** or **[CAL]** key to go to step 10.
 - When the current setting is to be changed, press the **[RE-ZERO]** key. The balance is now in the digital input mode. To use the weighing input mode, press and hold the **[MODE]** key.

Enter the lower limit value in the same way as described in step 8. Then, go to step 10.

Step 10 Press the CAL key to exit the comparator function and return to the weighing mode.

10-8-2. Example 2

Continuous comparison, including "near zero", reference value and tolerance value.

Selecting a comparator mode

- Step 1 Press and hold the **SAMPLE** key until **ba5fnc** of the function table is displayed, then release the key.
- Step 2 Press the **SAMPLE** key several times to display **Cp fnc**.
- Step 3 Press the **PRINT** key.
- Step 4 Press the **RE-ZERO** key several times to display **Cp 4**.
- Step 5 Press the **SAMPLE** key to display **Cp in**.
- Step 6 Press the **RE-ZERO** key several times to display **Cp in 1**.
- Step 7 Press the **PRINT** key to store the selected mode.

Entering the reference and tolerance values

- Step 8 With **Cp ref** displayed, press the **PRINT** key. The current setting of the reference value is displayed with all the digits blinking.
- When the current setting is not to be changed, press the **PRINT** or **CAL** key to go to step 9.
 - When the current setting is to be changed, press the **RE-ZERO** key. The balance is now in the digital input mode. To use the weighing input mode, press and hold the **MODE** key.

Digital input mode

Change the setting using the following keys.

- SAMPLE** key To select the digit to change the value.
- RE-ZERO** key ... To change the value of the digit selected.
- MODE** key To switch the polarity.
- PRINT** key To store the new setting and go to step 9.
- CAL** key To cancel the new setting and go to step 9.

Weighing input mode

Press the **RE-ZERO** key. The balance displays **00 g**. Place a sample, with a mass that corresponds to the reference value, on the pan. Press the **PRINT** key to store the reference value. Remove the sample. The balance displays **Cp 1mt**.

- Step 9 With **Cp 1mt** displayed, press the **PRINT** key. The current setting of the tolerance value is displayed with all the digits blinking.
- When the current setting is not to be changed, press the **PRINT** or **CAL** key to go to step 10.
 - When the current setting is to be changed, press the **RE-ZERO** key. The balance is now in the digital input mode. Change the setting using the following keys.
- SAMPLE** key To select the digit to change the value.
 - RE-ZERO** key ... To change the value of the digit selected.
 - PRINT** key To store the new setting and go to step 10.
 - CAL** key To cancel the new setting and go to step 10.

Note Enter the tolerance value in percentage, with the reference value as 100%.
Only the digital input mode is available for setting the tolerance value.
The **MODE** key is not used to set the tolerance value.

Step 10 Press the **CAL** key to exit the comparator function and return to the weighing mode.

Note When Pound/Ounce is selected as a weighing unit, enter the values in ounces for comparison.
In the density mode, comparison is performed to the density obtained.

10-8-3. Adding the Comparison Results

By setting the "Comparison results (Cp-r)" of the function table to "1", the comparison results can be added to the data output using the RS-232C serial interface. Use A&D standard format (type 0). The AD-8121B printer can not be used.

The comparison results are added after the header in A&D standard format as below.

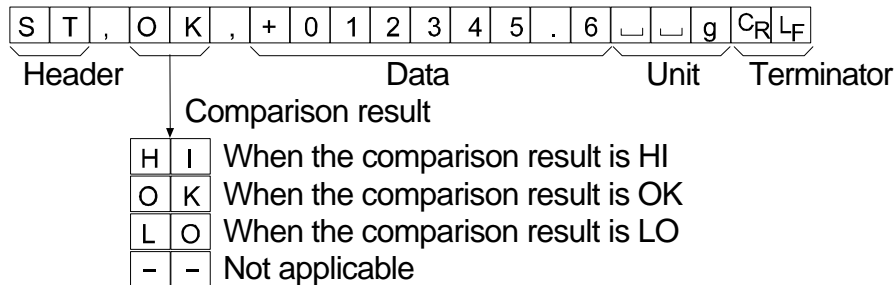

10-8-4. Main Display Comparison Function

The main display comparison function displays the comparison results in a magnified way, on the main portion of the display in place of the weight value.

Selecting a unit

Step 1 Press the **MODE** key to select a unit to be used for comparison.

Note While the main display comparison function is in use, unit selection using the **MODE** key is not available.

Setting the function table

Step 2 Press and hold the **SAMPLE** key until **ba5fnc** of the function table is displayed, then release the key.

Step 3 Press the **SAMPLE** key several times to display **Cp fnc**.

Step 4 Press the **PRINT** key.

Step 5 Press the **SAMPLE** key several times to display **Cp-b 0**.

Step 6 Press the **RE-ZERO** key to display **Cp-b 1**.

Note To disable the main display comparison function, set the "Main display comparison (Cp-b)" parameter to "0".

Step 7 Press the **PRINT** key to store the setting.

Step 8 Press the **CAL** key to return to the weighing mode.

Setting the comparator values

Setting the comparator values as described in the previous section.

This example uses **Cp 3** (Continuous comparison, excluding "near zero").

Using the main display comparison function

Step 1 Press the **RE-ZERO** key to set the display to zero.

Step 2 Place a sample on the pan. The balance performs a comparison using the specified comparison values and displays the comparison results, **HI**, **OK** or **LO**.

Step 3 Each time the **MODE** key is pressed, the balance switches between the standard display and the main display comparison. Note that "go" appears for **OK**.

Notes

- While the main display comparison function is in use, the processing indicator  illuminates as shown in the illustration.
- If the comparison is not performed, for example, because the weight value is near zero or unstable, the balance displays the weight value even when the main display comparison function is used.
- Even while the main display comparison function is in use, the balance re-zeroing and data output are possible.
- Only the unit selected before this function can be used.
- While the main display comparison function is in use, the data memory function is not available.
- To disable the main display comparison function, set the "Main display comparison (Cp-b)" parameter to "0".

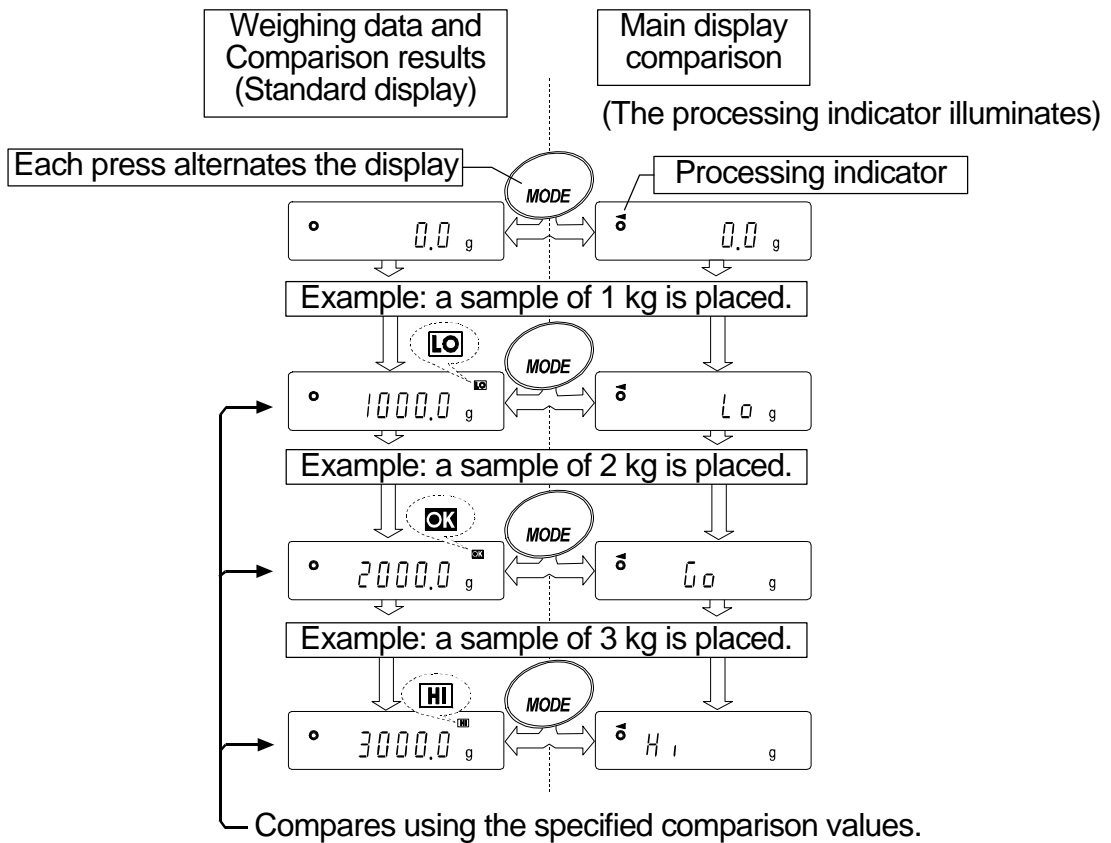

11. ID Number And GLP Report

- The ID number is used to identify the balance when Good Laboratory Practice (GLP) is used.
- The ID number is maintained in non-volatile memory even if the AC adapter is removed.
- The GLP output format is selected at "GLP output (info)" of the function table and can be output to a personal computer or printer using the RS-232C serial interface.
- The GLP output format includes the balance manufacturer, model, serial number, ID number, date, time and space for signature for weighing data, the weight used and results for calibration or calibration test data.
- The balance can output the following reports for GLP.
 - "Calibration report" of the calibration, using the internal mass (Calibration due to changes in temperature and one-touch calibration.)
 - "Calibration report" of the calibration, using an external weight.
 - "Calibration test report" of the calibration test, using an external weight.
 - "Title block" and "End block" for the weighing data.
- Calibration and calibration test data can be stored in memory to output several reports at the same time. Refer to "12. Data Memory" for details.
- For details on confirming and setting the time and date for the GX-K series. Refer to "10-7. Clock and Calendar Function".

Caution

- **GF-K series does not store the calibration report in memory.**
- **GF-K series does not use the time and date function. Use the calendar function of AD-8121B printer.**

11-1. Setting The ID Number

- Step 1 Press and hold the **[SAMPLE]** key until **[ba5fnc]** of the function table is displayed, then release the key.
- Step 2 Press the **[SAMPLE]** key several times to display **[id]**.
- Step 3 Press the **[PRINT]** key. Set the ID number using the following keys.
[RE-ZERO] key To set the character of the digit selected.
 Refer to the display character set shown below.
[SAMPLE] key To select the digit to change the value.
[PRINT] key To store the new ID number and display **[ba5fnc]**.
[CAL] key To cancel the new ID number and display **[ba5fnc]**.
- Step 4 With **[ba5fnc]** displayed, press the **[CAL]** key to return to the weighing mode.

Display character set

| | | | | | | | | | | | | | | | | | | | | | | | | | | | | | | | | | | | | | |
|---|---|---|---|---|---|---|---|---|---|---|---|---|---|---|---|---|---|---|---|---|---|---|---|---|---|---|---|---|---|---|---|---|---|---|---|---|---|
| 0 | 1 | 2 | 3 | 4 | 5 | 6 | 7 | 8 | 9 | - | ␣ | A | B | C | D | E | F | G | H | I | J | K | L | M | N | O | P | Q | R | S | T | U | V | W | X | Y | Z |
| 0 | 1 | 2 | 3 | 4 | 5 | 6 | 7 | 8 | 9 | - | ␣ | A | B | C | D | E | F | G | H | I | J | K | L | M | N | O | P | Q | R | S | T | U | V | W | X | Y | Z |

␣ Space

11-2. GLP Report

Set the following parameters to output the report.

- To print the report, set the "GLP output (i nfo)" parameter to "1" and use MODE 3 of the AD-8121B. Refer to "16-2. Connection to the AD-8121B Printer" for details on using the printer.
- To output the report to a personal computer using the RS-232C interface, set the "GLP output (i nfo)" parameter to "2".
- If the time and date are not correct, set the correct time and date in "Clock (Cl adj)" of the function table.

Notes

- For operational details about calibration and calibration test, refer to "8. Calibration".
- The GF-K series does not output time and date to the general format.

Calibration report using the internal mass

Setting of "i nfo 1"

AD-8121 printer format

```

      A & D
MODEL      GX-30K
S/N        01234567
ID         ABCDEFG
DATE       2004/12/31
TIME       12:34:56
CALIBRATED(INT.)
SIGNATURE
-----
  
```

Setting of "i nfo 2"

General format

```

~A~&~D<TERM>
MODEL~GX-30K<TERM>
S/N~01234567<TERM>
ID~ABCDEFG<TERM>
DATE<TERM>
~2004/12/31<TERM>
TIME<TERM>
~12:34:56<TERM>
CALIBRATED(INT.)<TERM>
SIGNATURE<TERM>
<TERM>
<TERM>
-----<TERM>
<TERM>
<TERM>
  
```

← Manufacturer →
 ← Model →
 ← Serial number →
 ← ID number →
 ← Date →
 ← Time →
 ← Calibration type →
 ← Signature →

- ␣ Space, ASCII 20h
- <TERM> Terminator, CR, LF or CR
- CR Carriage return, ASCII 0Dh
- LF Line feed, ASCII 0Ah

Calibration report using an external weight

Setting of "i nfo 1"

AD-8121 printer format

```

      A & D
MODEL   GX-30K
S/N     01234567
ID      ABCDEFG
DATE    2004/12/31
TIME    12:34:56
CALIBRATED(EXT.)
CAL. WEIGHT
      +20000.0 g
SIGNATURE
-----
    
```

- └ Space, ASCII 20h
- <TERM> Terminator, CR, LF or CR
- CR Carriage return, ASCII 0Dh
- LF Line feed, ASCII 0Ah

Setting of "i nfo 2"

General format

```

-----A&~D<TERM>
MODEL-----GX-30K<TERM>
S/N-----01234567<TERM>
ID-----ABCDEFG<TERM>
DATE<TERM>
-----2004/12/31<TERM>
TIME<TERM>
-----12:34:56<TERM>
CALIBRATED(EXT.)<TERM>
CAL.WEIGHT<TERM>
-----+20000.0~~g<TERM>
SIGNATURE<TERM>
<TERM>
<TERM>
-----<TERM>
<TERM>
<TERM>
    
```

Calibration test report using an external weight

Note Calibration test does not perform calibration.

Setting of "i nfo 1"

AD-8121 printer format

```

      A & D
MODEL   GX-30K
S/N     01234567
ID      ABCDEFG
DATE    2004/12/31
TIME    12:34:56
CAL. TEST(EXT.)
ACTUAL
      0.0 g
      +19999.9 g
TARGET
      +20000.0 g
SIGNATURE
-----
    
```

- └ Space, ASCII 20h
- <TERM> Terminator, CR, LF or CR
- CR Carriage return, ASCII 0Dh
- LF Line feed, ASCII 0Ah

Setting of "i nfo 2"

General format

```

-----A&~D<TERM>
MODEL-----GX-30K<TERM>
S/N-----01234567<TERM>
ID-----ABCDEFG<TERM>
DATE<TERM>
-----2004/12/31<TERM>
TIME<TERM>
-----12:34:56<TERM>
CAL.TEST(EXT.)<TERM>
ACTUAL<TERM>
-----0.0~~g<TERM>
-----+19999.9~~g<TERM>
TARGET<TERM>
-----+20000.0~~g<TERM>
SIGNATURE<TERM>
<TERM>
<TERM>
-----<TERM>
<TERM>
<TERM>
    
```

Title block and end block

When weight values are recorded as GLP data, a "Title block" is inserted at the beginning and an "End block" is inserted at the end of a group of weight values in the GLP report.

Notes

- To output the report to an AD-8121B , use MODE 3 of the AD-8121B.
- If the data memory function is used, the "Title block" and "End block" can not be output.

Operation

- Step 1 With the weighing data displayed, press and hold the **PRINT** key, until **5start** is displayed, then release the key. The "Title block" is output.
- Step 2 The weighing data is output according to the parameter setting of the data output mode (prt) of the function table.
- Step 3 Press and hold the **PRINT** key until **recend** is displayed, then release the key. The "End block" is output.

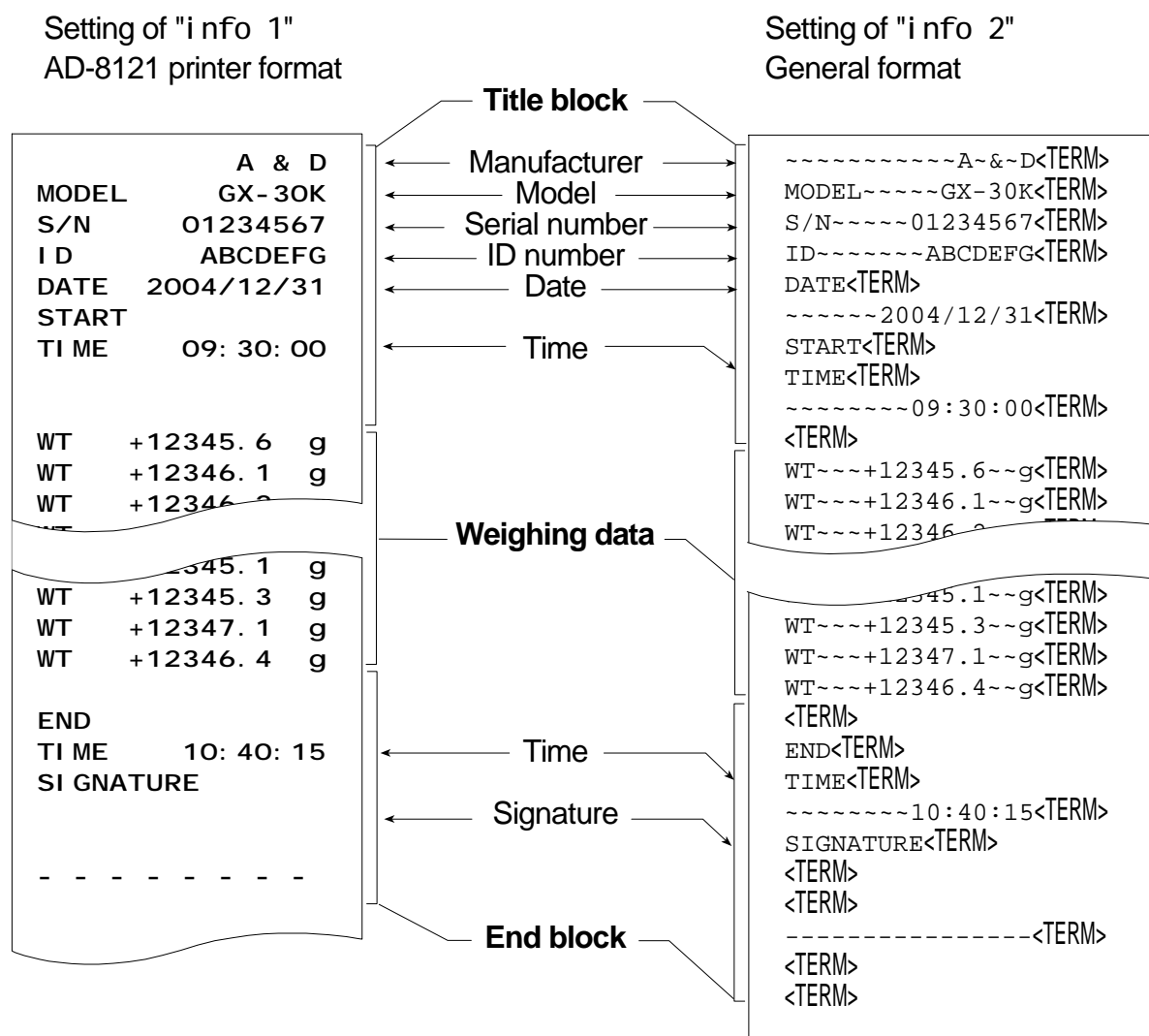

- ␣ Space, ASCII 20h
- <TERM> Terminator, CR , LF or CR
- CR Carriage return, ASCII 0Dh
- LF Line feed, ASCII 0Ah

12. Data Memory

Data memory is a function to store weighing data, calibration data and unit mass in memory. Of the data in memory, the balance can only display the weighing data. The weighing data and calibration data in memory are available for outputting at one time to a printer or personal computer. One of the following data sets can be stored:

| | | GX-K series | GF-K series |
|--|-------------------------|----------------|---------------|
| Weighing data | Excluding date and time | Up to 200 sets | Up to 40 sets |
| | Including date and time | Up to 100 sets | — |
| Calibration result of Internal and external calibration and calibration test | | Last 50 sets | — |
| Unit mass in the counting mode | | Up to 50 sets | Up to 20 sets |
| Upper and lower limit values of comparator function | | Up to 20 sets | |
| Tare value | | Up to 20 sets | |

Note GF-K series does not output time and date.

12-1. Notes on Using Data Memory

- To use the memory function, set the "Data memory (data)" parameter of the function table. In addition, for weighing data, set the "Time/Date output (5-td)" parameter. For details on setting the data memory, refer to "10-2. The Function Table".
- For weighing data of the GX-K series, the data contents to be stored and the storage capacity depend on the "Time/Date output (5-td)" parameter setting.

Releasing "Cl r"

If a different type of data exists in memory when the data is stored, "Cl r" blinks the upper left of the display. For example, you want to store weighing data but calibration data or unit mass data remains in memory.

Upper left of the display

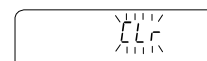

Under such a condition, before storing data, delete the data in memory as follows:

Step 1 Press and hold the **PRINT** key until **SCI r hb** with "no" blinking is displayed, then release the key.

Step 2 Press the **RE-ZERO** key to display **SCI r gb** with "go" blinking. The type of data stored in memory appears in the upper left of the display as shown below:

| | |
|-------------------------------------|------|
| Unit mass in the counting mode | PpC |
| Weighing data without time and date | -d- |
| Weighing data with time and date | d-t |
| Calibration result | Hi 5 |
| parameters of comparator | Cp |
| Tare value | tr |

Step 3 Press the **PRINT** key to delete all the data in memory.

Step 4 The balance displays **end** and returns to the weighing mode.

12-2. Data Memory for Weighing Data

- The GX-K series can store 200 sets of weighing data in memory (if time and date are added, the GX-K series can store 100 sets). Even if the AC adapter is removed, the data is maintained in non-volatile memory.
- The GF-K series can store 40 sets of weighing data in memory. Even if the AC adapter is removed, the data is maintained in non-volatile memory. The GF-K series does not store time and date.
- It is not necessary that the printer or personal computer be continually connected to the balance, because the balance stores the weighing data in memory.
- The data in memory is available to be displayed on the balance for confirmation, or to output several sets of data at one time to a printer or personal computer. In the function setting, what data is to be added to the output data (ID number, data number, time and date) can be selected.

Storing the weighing data

Note If "Cl r" blinks in the upper left of the display, delete the data in memory.

Step 1 Set the "Data memory (data)" parameter to "2".

Step 2 Set the "Time/Date output (5-td)" parameter as necessary.

Step 3 The storing mode depends on the "Data output mode (prt)" parameter setting. Four types of storing modes are available to store data.

Key modeWhen the key is pressed and the displayed value is stable, the balance stores the weighing data.

Auto print modes AWhen the displayed value is stable and the conditions of "Auto print polarity", "Auto print difference" and zero point (reference value) are met, the balance stores the weighing data.

Auto print modes BWhen the displayed value is stable and the conditions of "Auto print polarity", "Auto print difference" and last stable data (reference value) are met, the balance stores the weighing data.

Interval memory mode.....Weighing data is stored at an interval specified in "Interval time (i nt)". Press the key to start and stop this mode.

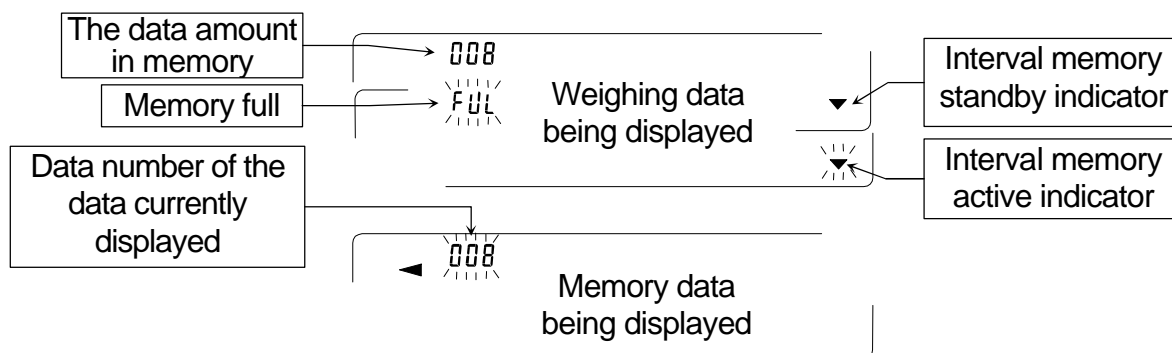

Caution

- When weighing data is being stored in memory, the data can not be output to a personal computer using the RS-232C interface.

- "fUI " indicates that memory is full or the memory capacity has been reached. More data can not be stored unless the memory data is deleted.
- Automatic self calibration can not be used while the interval memory mode is active.
- The following commands can not be used during data storage.
 - Q Query command for weighing data.
 - S Query command for stable weighing data.
 - SI Query command for weighing data.
 - SIR Query command for continuous weighing data.

Setting the function table

Parameter settings for each output mode are as follows:

| Mode \ Item | Data output mode | Auto print polarity, difference | Data memory function | Interval time |
|----------------------|------------------|---------------------------------|----------------------|---------------|
| Key mode | prt 0 | Not used | data 2 | Not used |
| Auto print mode A | prt 1 | ap-a 0-2 | data 2 | |
| Auto print mode B | prt 2 | ap-b 0-2 | data 2 | |
| Interval memory mode | prt 3 | Not used | data 2 | int 0-8 |

Set each item for GX-K series, depending on the situation, as follows:

| | | | | | |
|-------------|-----|---------|---------------|-----------|--------|
| Data number | No | d-no 0 | Time and date | No | 5-td 0 |
| | Yes | d-no 1 | | Time only | 5-td 1 |
| ID number | No | 5-i d 0 | | Date only | 5-td 2 |
| | Yes | 5-i d 1 | | Both | 5-td 3 |

When 5-td 1, 2 or 3 is selected, the amount of data to be stored is 100 sets.

Set each item for GF-K series, depending on the situation, as follows:

| | | |
|-------------|-----|---------|
| Data number | No | d-no 0 |
| | Yes | d-no 1 |
| ID number | No | 5-i d 0 |
| | Yes | 5-i d 1 |

GF-K series does not use time and date.

Enabling the data memory function

- Step 1 Press and hold the **SAMPLE** key until **ba5fnc** is displayed, then release the key.
- Step 2 Press the **SAMPLE** key several times to display **dout**.
- Step 3 Press the **PRINT** key.
- Step 4 Press the **SAMPLE** key three times to display **data 0**.
- Step 5 Press the **RE-ZERO** key to display **data 2**.
- Step 6 Press the **PRINT** key to store the setting.
- Step 7 Press the **CAL** key to return to the weighing mode.

Recalling the memory data

Confirm that the "Data memory (data)" parameter is set to "2".

Step 1 Press and hold the **PRINT** key until **reCall** is displayed, then release the key.

Step 2 Press the **PRINT** key to enter the memory recall mode. The type of data appears in the upper left of the display as shown to the right. Recall the data in memory using the following keys.

RE-ZERO key...To proceed to the next data set.

MODE key.....To go back to the previous data set.

PRINT key.....To transmit the current data using the RS-232C interface.

With **SAMPLE** held down, press the **CAL** key
To delete the current data.

Note Deleting the data will not increase the number of data that can be stored.

CAL key.....To exit the memory recall mode.

Step 3 Press the **CAL** key to return to the weighing mode.

Indicators

-d-

Weighing data
without time and date

d-t

Weighing data with
time and date

Transmitting all memory data at one time

Confirm that the "Serial interface (5i f)" parameters are set properly. Refer to "10. Function Table" and "16-2. Connection To Peripheral Equipment".

Step 1 Press and hold the **PRINT** key until **reCall** is displayed, then release the key.

Step 2 Press the **SAMPLE** key to display **out**.

Step 3 Press the **PRINT** key to display **out hb** with "no" blinking.

Step 5 Press the **RE-ZERO** key to display **out gb** with "go" blinking.

Step 6 Press the **PRINT** key to transmit all data using the RS-232C interface.

Step 7 The balance displays **Clear** when all data is transmitted.
Press the **CAL** key to return to the weighing mode.

Indicators

-d-

Weighing data
without time and date

d-t

Weighing data with
time and date

Deleting all memory data at one time

Step 1 Press and hold the **PRINT** key until **reCall** is displayed, then release the key.

Step 2 Press the **SAMPLE** key several times to display **Clear**.

Step 3 Press the **PRINT** key to display **Clr hb** with "no" blinking.

Step 4 Press the **RE-ZERO** key to display **Clr gb** with "go" blinking.

Step 5 Press the **PRINT** key to delete all data

Step 6 The balance displays **end** when all data is deleted.
The balance displays **reCall**.

Step 7 Press the **CAL** key to return to the weighing mode.

12-3. Data Memory for Calibration and Calibration Test

- Calibration data (when and how it is performed) and calibration test data can be stored in memory.
- All the data in memory is available to be output at one time to a printer or personal computer.
- Up to 50 data sets of the latest calibration or calibration test can be stored. When the memory capacity has been reached, "FUL" illuminates in the upper left of the display as shown at the right.

Indicator

FUL

Storing the calibration and calibration test data

Note If "CI r" appears blinking in the upper left of the display, delete the data in memory.

Store the calibration and calibration test data as follows:

- Step 1 Set the "Data memory (data)" parameter to "3".
- Step 2 Set the "GLP output (i nfo)" parameter to "1" or "2".
- Step 3 With the settings above, each time calibration or calibration test is performed, the data is stored automatically.

Transmitting the memory data

Note

- Confirm that the "Serial interface (5i f)" parameters are set properly. Refer to "10. Function Table" and "16-2. Connection To Peripheral Equipment".
- Confirm that the "Data memory (data)" parameter is set to "3".

- Step 1 Press and hold the **PRINT** key until **out** is displayed, then release the key.
- Step 2 Press the **PRINT** key to display **out hb** with "no" blinking.
- Step 3 Press the **RE-ZERO** key to display **out gb** with "go" blinking.
- Step 4 Press the **PRINT** key to transmit all memory data using the RS-232C interface.
- Step 5 The balance displays **Clear** when all memory data is output. Press the **CAL** key to return to the weighing mode.

In the upper left of the display

H,5

Deleting data stored in memory

- Step 1 Press and hold the **PRINT** key until **out** is displayed, then release the key.
- Step 2 Press the **SAMPLE** key to display **Clear**.
- Step 3 Press the **PRINT** key to display **CI r hb** with "no" blinking.
- Step 4 Press the **RE-ZERO** key to display **CI r gb** with "go" blinking.
- Step 5 Press the **PRINT** key to delete all data.
- Step 6 The balance displays **out** when all the data has been deleted. Press the **CAL** key to return to the weighing mode.

In the upper left of the display

H,5

12-4. Data Memory for Unit Mass in the Counting Mode

- The GX-K series can store 50 data of unit mass for the counting mode. "p01" is the standard memory of unit mass. Another 49 data of unit mass can be stored.
- The GF-K series can store 20 data of unit mass for the counting mode. "p01" is the standard memory of unit mass. Another 19 data of unit mass can be stored.
- Even if the AC adapter is removed, the data is maintained in non-volatile memory.
- The unit mass in memory can be recalled and used for weighing.
- The unit mass in memory can be recalled and changed.

Note

- The recalled unit mass can be changed, using the weighing input mode or the digital input mode. The weighing input mode uses the specified number of samples to store the unit mass. The digital input mode enters the unit mass using the keys.

12-4-1. Storing the unit mass

To store a new unit mass: Recall the stored unit mass to be changed. Then, change the recalled unit mass using the weighing input mode or the digital input mode, and store the new unit mass.

GX-K series can store a unit mass from "Pp01" to "p50".

GF-K series can store a unit mass from "Pp01" to "p20".

Step 1 Set the "Data memory (data)" parameter to "1".

Step 2 Press the **MODE** key to select **pcs** (counting mode).
If "Cl r" appears blinking in the upper left of the display, delete the data in memory.

Note If the counting mode can not be selected, refer to "5. Weighing Units".

Step 3 Press and hold the **PRINT** key until the balance enters the sample unit mass confirmation mode. The unit mass last selected is displayed

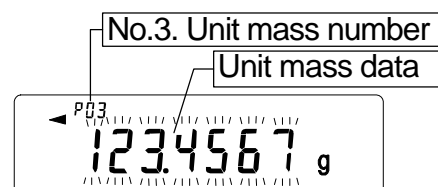

Step 4 Select the unit mass number to be used, using the following keys.

RE-ZERO key .. To increase the unit mass number by one.

MODE keyTo decrease the unit mass by one.

Number of GX-K series: p01 to p50
Number of GF-K series: p01 to p20

Step 5 To change the selected unit mass:

- To use the weighing input mode, press the **SAMPLE** key to enter the weighing input mode. Go to "Weighing input mode" on the next page.
- To use the digital input mode, press the **SAMPLE** key, then press and hold the **MODE** key to enter the digital input mode. Go to "Digital input mode" on the next page.

Notes

- **ACAI can not be performed directly on the recalled unit mass.**

- Using the "UN:mm" command, the unit mass can be recalled.
The unit mass recalled can be output using the "?UW" command.
The unit mass can be changed using the "UW:" command.
"mm" indicates a two-digit numerical value 01 to 50, which corresponds to p01 - p50 of the GX-K series.
"mm" indicates a two-digit numerical value 01 to 20, which corresponds to p01 - p20 of the GF-K series.

Weighing input mode

In the weighing input mode, the specified number of samples is placed on the pan to store the unit mass. Re-storing the unit mass or performing Automatic Counting Accuracy Improvement (ACAI) on the re-stored unit mass is possible. Follow the procedure described in "6-2. Counting Mode (PCS)".

Use the following keys to store a unit mass in the weighing input mode.

RE-ZERO key .. To set the display to zero. **10 - pcs** ? **10 0 pcs**

SAMPLE key ... To change the number of samples to be stored. **10 0 pcs** ? **25 0 pcs**

PRINT key Press, after a sample is placed, to store the unit mass. Go to step 3 of the previous page.

CAL key To return to the unit mass confirmation mode. Go to step 3 of the previous page.

MODE key Press and hold to go to the digital input mode.

Digital input mode

To use this mode, the sample unit mass must be known beforehand. In the digital input mode, the unit mass value is entered digitally using the keys. The display in the digital input mode is shown to the right.

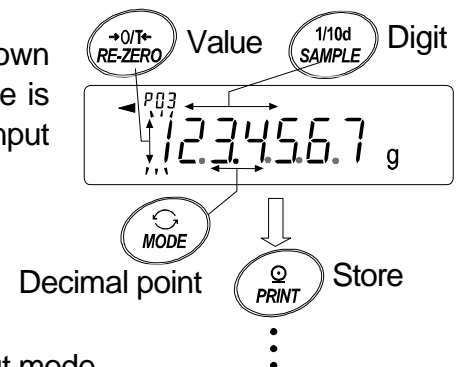

Note ACAI can not be used on the unit mass stored using the digital input mode.

Use the following keys to store a unit mass in digital input mode.

SAMPLE key ... To select the digit to be changed.

RE-ZERO key .. To change the value of the selected digit.

MODE key To change the decimal point position.

PRINT key To store the unit mass. Go to step 3 of the previous page.

CAL key To return to the unit mass confirmation mode. Go to step 3 of the previous page.

MODE key Press and hold to go to the weighing input mode.

Note If the new unit mass is out of the setting range, "error 2" is displayed. Refer to "20. Specifications" for the minimum unit mass.

12-4-2. Recalling the unit mass

Step 1 Follow steps 1 through 3 in "12-4-1. Storing the unit mass" on the previous page, to enter the sample unit mass confirmation mode.

Step 2 Select the unit mass number using the following keys.

GX-K series: p01 to p50,

GF-K series: p01 to p20.

RE-ZERO key To increase the unit mass number by one.

MODE key To decrease the unit mass number by one.

Step 3 Press the **PRINT** key to confirm the selection and to return to the weighing mode.

To cancel the selection and return to the weighing mode, press the **CAL** key.

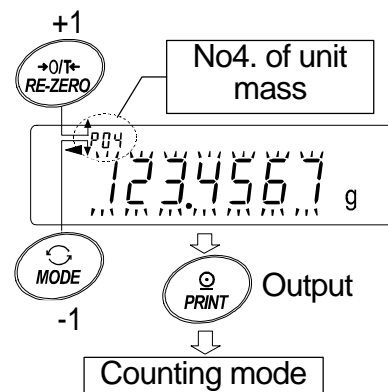

12-5. Data Memory for Comparator Settings

- The data memory function can store 20 sets of upper and lower limit values for the comparator mode. The reference value or tolerance value for the comparator mode can not be stored in memory.
- The upper and lower limit values in memory can be recalled easily using the **[MODE]** key and used for weighing.
- The upper and lower limit values in memory can be recalled and changed.

Note

The recalled upper and lower limit values can be changed, using the digital input mode or the weighing input mode. The digital input mode enters the upper and lower limit values using the keys. The weighing input mode uses a sample to store the upper and lower limit values.

12-5-1. Storing the upper and lower limit values

To store new upper and lower limit values: Recall the stored upper and lower limit values to be changed ("C01" to "C20"). Then, change the recalled upper and lower limit values using the digital input mode or the weighing input mode, and store the new value.

Note

- While the data memory function is in use, unit selection using the **[MODE]** key is not available.
- If "Cl r" appears blinking in the upper left of the display, delete the data in memory. Refer to "12-1. Notes on Using Data Memory".

Step 1 Press the **[MODE]** key to select a unit to be used for storage.

Step 2 Set the "Data memory (data)" parameter to "4".

Step 3 Press and hold the **[PRINT]** key until the balance enters the upper and lower limit values confirmation mode. The upper limit value last selected is displayed.

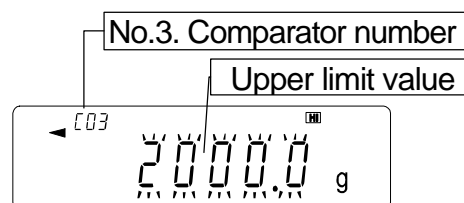

Step 4 Select the comparator number to be used, using the following keys.

[RE-ZERO] key To increase the comparator number by one.

[MODE] key To decrease the comparator number by one.

Each time the **[RE-ZERO]** key or **[MODE]** key is pressed, the displayed value changes as follows: ? C03 **[HI]** ? C03 **[LO]** ? C04 **[HI]** ? C04 **[LO]** ?

Step 5 To change the selected upper and lower limit values:

- To use the digital input mode, press the **[SAMPLE]** key to enter the digital input mode. Go to "Digital input mode" on the next page.
- To use the weighing input mode, press the **[SAMPLE]** key, then press and hold the **[MODE]** key to enter the weighing input mode. Go to "Weighing input mode" on the next page.

Notes

- Using the "CN:mm" command, the comparator limit values can be recalled. The upper limit value recalled can be output using the "?HI" command. The lower limit value recalled can be output using the "?LO" command. The upper limit value can be changed using the "HI:" command. The lower limit value can be changed using the "LO:" command. "mm" indicates a two-digit numerical value 01 to 20, which corresponds to C01 - C20.

Digital input mode

In the digital input mode, the upper and lower limit values are entered digitally using the keys. Use the following keys to store upper and lower limit values in digital input mode.

- SAMPLE** key... To select the digit to be changed.
- RE-ZERO** key... To change the value of the selected digit.
- MODE** key..... To switch the polarity.
- PRINT** key..... To store the upper and lower limit values. Go to step 3 of the previous page.
- CAL** key..... To return to the upper and lower limit values confirmation mode Go to step 3 of the previous page.
- MODE** key Press and hold to go to the weighing input mode.

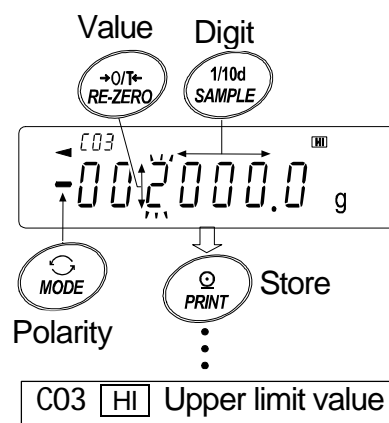

Weighing input mode

In the weighing input mode, a sample is placed on the pan to store the upper and lower limit values.

Notes

- Pressing the **CAL** key will interrupt the operation and the balance will return to the upper and lower limit values confirmation mode (step 3 in "Storing the upper and lower limit values").
- To go to the digital input mode, press and hold the **MODE** key.

Step 1 The first display in the weighing input mode depends on the comparator number selected in step 4 in "Storing the upper and lower limit values".

For example, when "C03 HI" is selected in step 4, the display is the current weight value and the comparator number with **HI** blinking.

Step 2 Place a container on the weighing pan, if necessary. Press the **RE-ZERO** key to set the display to zero.

Step 3 Place a sample corresponding to the upper limit value, on the pan or in the container.

Step 4 Press the **PRINT** key to store the upper limit value.

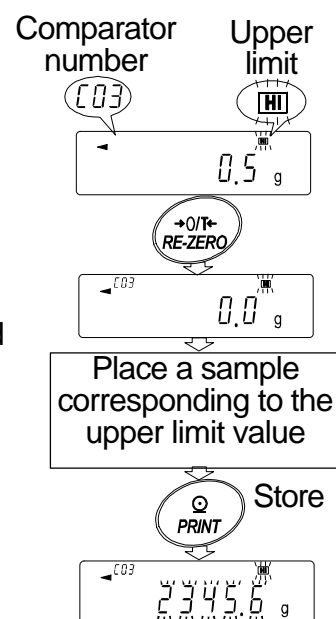

12-5-2. Recalling the upper and lower limit values (Quick selection mode)

The procedure below describes an easy way to recall the upper and lower limit values to be used for weighing. When the recalled upper and lower limit values are to be changed, refer to "12-5-1. Storing the upper and lower limit values".

Note

- Refer to "12-5-1. Storing the upper and lower limit values" for the method to store the upper and lower limit values.

Step 1 Set the "Data memory (data)" parameter to "4".

Step 2 Press the **MODE** key to enter the upper/lower limit value recalling mode. The upper limit value last selected with its comparator number appears. The display is as shown to the right, with all the digits blinking.

Step 3 Press the **MODE** key to select the value. Each time the **MODE** key is pressed, the displayed value changes as follows:

(.....? C03 **HI** ? C03 **LO** ? C04 **HI** ?
C04 **LO** ?

Step 4 Press the **PRINT** key to confirm the selection. The balance returns to the weighing mode with the selected upper and lower limit values ready for use. To cancel the selection, press the **CAL** key. The balance returns to the weighing mode.

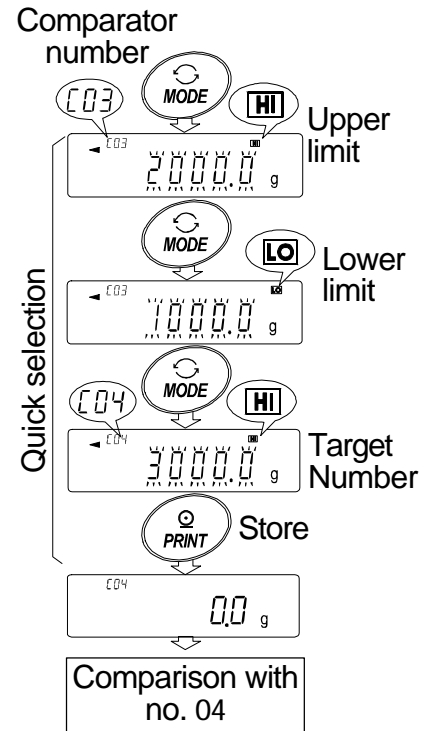

Note

- When no operation is performed in step 4 (after a few seconds of inactivity), the balance selects the value currently displayed and returns to the weighing mode automatically.

12-6. Data Memory for Tare Value

- The data memory function can store 20 sets of tare values for weighing.
- The tare value in memory can be recalled easily using the **MODE** key and used for weighing.
- The tare value in memory can be recalled and changed.

Notes

- **The recalled tare value can be changed, using the digital input mode or the weighing input mode. The digital input mode enters the tare value using the keys. The weighing input mode uses a sample tare container to store the tare value.**
- **The NET indicator illuminates during tare operation.**

12-6-1. Storing the tare value

To store a new tare value: Recall the stored tare value to be changed ("t01" to "t20"). Then, change the recalled tare value using the digital input mode or the weighing input mode, and store the new value.

Notes

- **The recalled tare value can be changed, using the digital input mode or the weighing input mode. The digital input mode enters the tare value using the keys. The weighing input mode uses a sample tare container to store the tare value.**
- **The NET indicator illuminates during tare operation.**
- **When the **RE-ZERO** key is pressed with nothing placed on the weighing pan, zero is displayed, The NET indicator does not illuminate.**
- **"t-- " appears when a tare operation is performed without using the tare value stored in memory.**
- **While the data memory function is in use, unit selection using the **MODE** key is not available.**
- **If "Cl r" appears blinking in the upper left of the display, delete the data in memory. Refer to "12-1. Notes on Using Data Memory".**

Step 1 Press the **MODE** key to select a unit to be used for storage.

Step 2 Set the "Data memory (data)" parameter to "5".

Step 3 Press and hold the **PRINT** key until the balance enters the tare value confirmation mode. The tare value last selected is displayed.

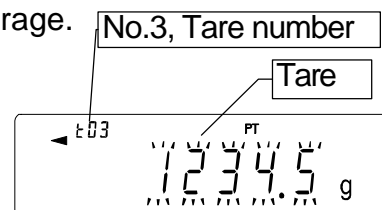

Step 4 Select the tare number to be used, using the following keys.

RE-ZERO key To increase the tare number by one.

MODE key To decrease the tare number by one.

CAL key To cancel it and to return to the weighing mode.

Each time the **RE-ZERO** key or **MODE** key is pressed, the displayed value changes as follows: ? t03 ? t04 ?? t20 ? t01 ?

Step 5 To change the selected tare value:

- To use the weighing input mode, press the **SAMPLE** key to enter the weighing input mode. Go to "Weighing input mode" on the next page.
- To use the digital input mode, press the **SAMPLE** key, then press and hold the **MODE** key to enter the digital input mode. Go to "Digital input mode" on the next page.

Notes

- Using the "PN:mm" command, the tare value can be recalled.
The tare value recalled can be output using the "?PT" command.
The tare value can be changed using the "PT:" command.
"mm" indicates a two-digit numeral value 01 to 20, which corresponds to t01 - t20.

Weighing input mode

In the weighing input mode, a sample tare container is placed on the pan to store the tare value.

Note

- Pressing the **CAL** key will interrupt the operation and the balance will return to the tare value confirmation mode (step 3 in "Storing the tare value").
- To go to the digital input mode, press and hold the **MODE** key.

Step 1 The first display in the weighing input mode is the current weight value and the selected tare number with **PT** blinking.

Step 2 Press the **RE-ZERO** key to set the display to zero.

Step 3 Place a tare (a container) on the weighing pan.

Step 4 Press the **PRINT** key to store the tare value.
Remove the tare from the pan.

Tare number

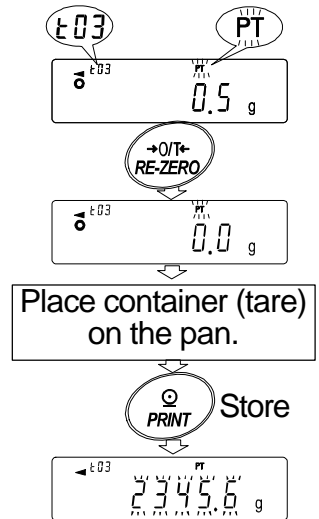

Digital input mode

In the digital input mode, the tare value is entered digitally using the keys. Use the following keys to store a tare value in digital input mode.

SAMPLE key ... To select the digit to be changed.

RE-ZERO key .. To change the value of the selected digit.

PRINT key To store the tare value.
Go to step 3 of "12-6-1. Storing the tare value".

CAL key To return to the tare value confirmation mode.
Go to step 3 of "12-6-1. Storing the tare value".

MODE key Press and hold to go to the weighing input mode.

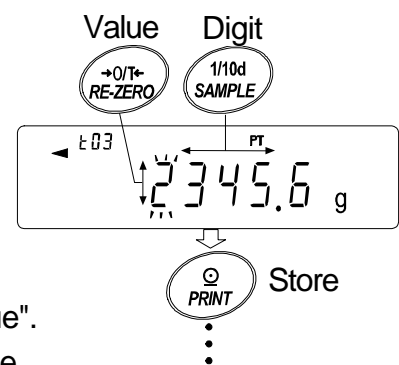

12-6-2. Recalling the tare value (Quick selection mode)

The procedure below describes an easy way to recall the tare value to be used for weighing. When the recalled tare value is to be changed, refer to "12-6-1. Storing the tare value".

Step 1 Set the "Data memory (data)" parameter to "5".

Step 2 Press the **MODE** key to enter the tare value recalling mode. The tare value last selected with its tare number appears. The display is as shown to the right, with all the digits blinking.

Step 3 Press the **MODE** key to select the value. Each time the **MODE** key is pressed, the displayed value changes as follows:
(.....? t03 ? t04 ?? t20 ? t01 ? ...)

Step 4 Press the **PRINT** key to confirm the selection. The balance returns to the weighing mode with the selected tare value ready for use. To cancel the selection, press the **CAL** key. The balance returns to the weighing mode.

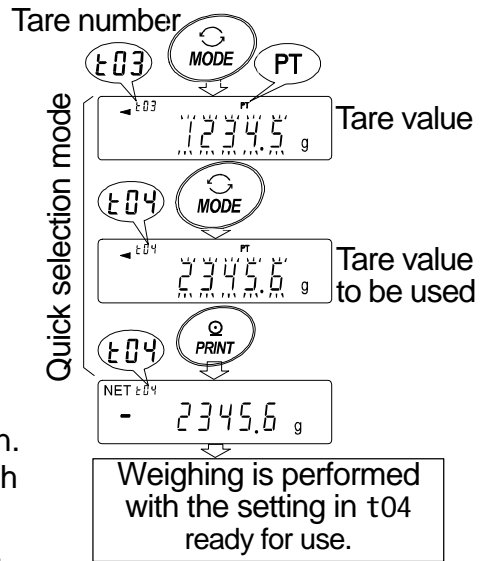

Note

- When no operation is performed in step 4 (after a few seconds of inactivity), the balance selects the value currently displayed and returns to the weighing mode automatically.

Canceling the tare value data

Cancel the tare value data as follows:

Step 1 Remove everything from the weighing pan and press the **RE-ZERO** key to cancel the tare value.

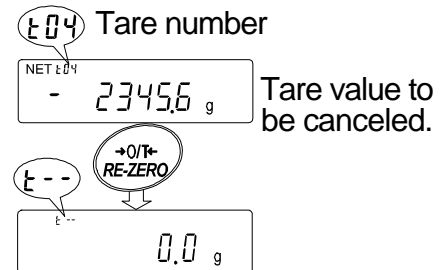

12-7. Data Memory: Quick Selection Mode

The data memory has a quick selection mode to recall data in memory quickly. Using the quick selection mode, the comparator settings or the tare value, whichever is selected in the function table, can be recalled, by a simple operation, using the **MODE** key.

Note

- While the data memory function is in use, unit selection using the **MODE** key is not available.

Use the quick selection mode as follows:

- Step 1 Press the **MODE** key to enter the memory data recalling mode.
The memory data last selected appears with all the digits blinking.
- Step 2 Press the **MODE** key to select the value.

Comparator settings: when the "Data memory (data)" parameter is set to "4"

Each time the **MODE** key is pressed, the displayed value changes as follows:

(.....? C03 **HI** ? C03 **LO** ? C04 **HI** ? C04 **LO** ?

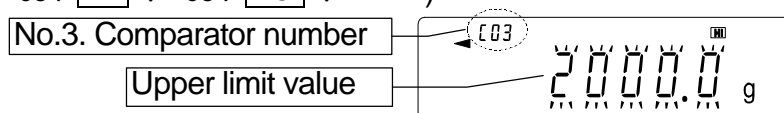

Tare value: when the "Data memory (data)" parameter is set to "5"

Each time the **MODE** key is pressed, the displayed value changes as follows:

(.....? t03 ? t04 ?? t20 ? t01 ?

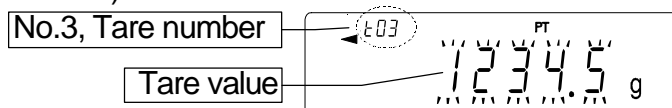

- Step 3 Press the **PRINT** key or leave the balance as is for a while (after a few seconds of inactivity) to confirm the selection. The balance returns to the weighing mode with the selected data ready for use.
To cancel the selection, press the **CAL** key. The balance returns to the weighing mode

12-8. Data Memory: Confirmation and Storage Mode

The confirmation and storage mode can change and store the recalled data.

Of the three types of memory data listed below, one may be selected in the function table, and is available for changes using this mode.

- Unit mass in the counting mode
- Comparator settings
- Tare value

Notes

- **To change the memory data other than specified in the function table, re-set the "Data memory (data)" parameter of the function table.**
- **For a detailed description of the procedure for each memory data, see the relevant section.**

Use the confirmation and storage mode as follows.

Step 1 Press and hold the **PRINT** key to enter the memory data recalling mode. The memory data last selected appears with all the digits blinking.

Step 2 Use the following keys to select the value.

RE-ZERO key To increase the memory data number by one.

MODE key To decrease the memory data number by one.

Unit mass: when the "Data memory (data)" parameter is set to "1"

Each time the **MODE** key or **RE-ZERO** key is pressed, the displayed value changes as follows:? p03 ? p04 ?

GX-K series can select "p01" to "p50".

GF-K series can select "p01" to "p20".

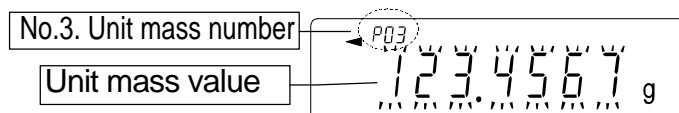

Comparator settings: when the "Data memory (data)" parameter is set to "4"

Each time the **MODE** key or **RE-ZERO** key is pressed, the displayed value changes as follows:? C03 **HI** ? C03 **LO** ? C04 **HI** ? C04 **LO** ?

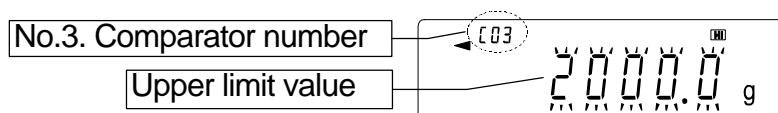

Tare value: when the "Data memory (data)" parameter is set to "5"

Each time the **MODE** key or **RE-ZERO** key is pressed, the displayed value changes as follows:? t03 ? t04 ?? t20 ? t01 ?

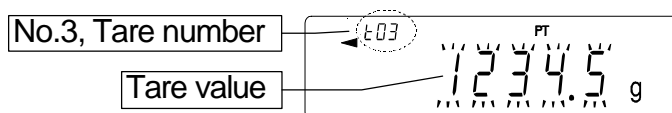

Step 3 Select a method.

- To perform a weighing using the selected memory data
Press the **PRINT** key to confirm the selection. The balance will return to the weighing mode with the selection ready for use.

- To change and store the selected memory data
Press the **SAMPLE** key to enter the storage mode.
Two inputting modes are available for entering the value to be stored.
 - Digital input mode
 - Weighing input mode

- To switch the inputting mode, press and hold the **MODE** key.

- To cancel the operation and return to the weighing mode, press the **CAL** key.

13. Underhook

The underhook can be used for weighing large samples, magnetic materials or for measuring density. The built-in underhook is revealed by removing the cover plates on the bottom of the balance. Use the underhook as shown below.

Caution

- Do not apply excessive force to the underhook.
- When not in use, attach the cover plate to prevent dust from getting into the balance.

 The weighing pan, pan support and draft gate fall off, when turning over the balance. Remove them first.

- Step 1 Remove the draft gate.
- Step 2 Remove the weighing pan and pan support.
- Step 3 Turn over the balance.
- Step 4 Remove the cover plates.
- Step 5 Hang from the underhook.

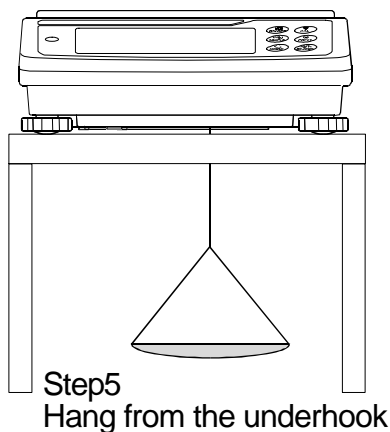
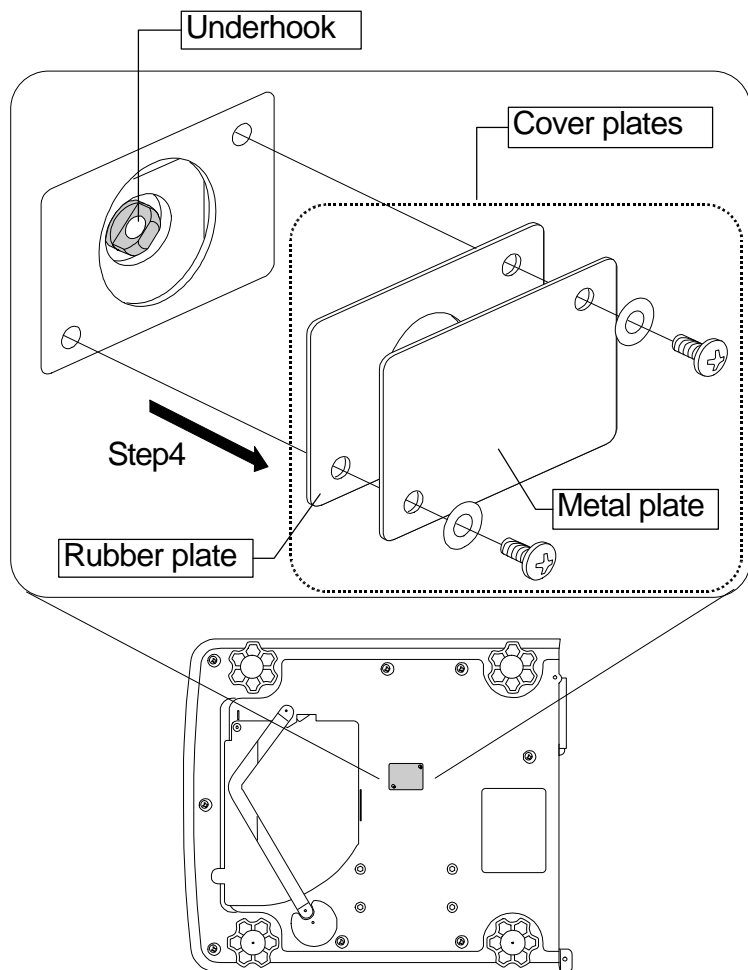
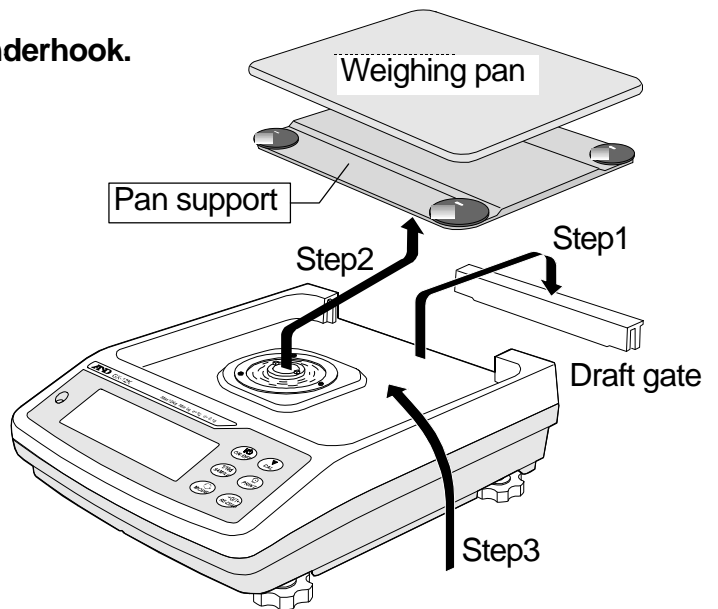

14. Programmable Unit

This is a programmable unit conversion function. It multiplies the weighing data in kilograms by an arbitrary coefficient set in "Programmable unit (ml t)" of the function table and displays the result. The coefficient must be within the range between the minimum and maximum shown below. If the coefficient set is beyond the range, an error is displayed and the balance returns to the coefficient setting mode, prompting to enter an appropriate value. A coefficient of 1 was set at the factory.

| Model | Minimum coefficient | Maximum coefficient |
|--|---------------------|---------------------|
| GX-8K GF-8K | 0.000001 | 100000 |
| GX-8K2 GX-12K GX-20K GX-30K GF-8K2 GF-12K GF-20K GF-30K | | 10000 |
| GX-32K GF-32K | | 1000 |

Operation

- Step 1 Press and hold the **[SAMPLE]** key until **[ba5fnc]** of the function table is displayed, then release the key.
- Step 2 Press the **[SAMPLE]** key several times to display **[ml t]**.
- Step 3 Press the **[PRINT]** key to enter the mode to confirm or set the coefficient.

Confirming the coefficient

- Step 4 The current coefficient is displayed with the first digit blinking.
- When it is not to be changed, press the **[CAL]** key and go to step 6.
 - When it is to be changed, press the **[RE-ZERO]** key and go to step 5.

Setting the coefficient

- Step 5 Set the coefficient using the following keys.
- [SAMPLE]** key ... To select a digit to change the value.
The selected digit blinks.
- [RE-ZERO]** key ... To change the value.
- [MODE]** key ... To change the decimal point position.
Each time the switch is pressed, the decimal point position changes as follows:
→0.000001→00.00001→...→000000.1→0000001
- [PRINT]** key ... To store the new coefficient, display **[end]** and go to step 6.
- [CAL]** key ... To cancel the new coefficient and go to step 6.

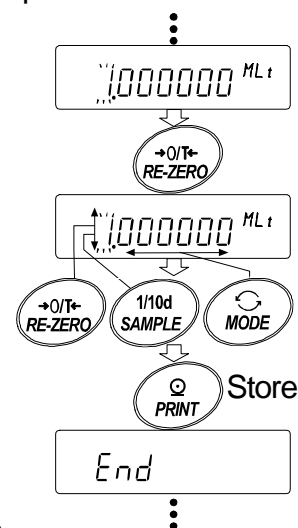

Quitting the operation

- Step 6 The balance displays **[Uni t]**. Press the **[CAL]** key to exit the programmable-unit function and return to the weighing mode.

Using the function

Press the **[MODE]** key to select the programmable-unit (no display on the unit section). Perform weighing as described in "6-1. Basic Operation (Gram Mode)". After weighing, the balance displays the result (weighing data in kilograms × coefficient).

15. Density Measurement

The balance is equipped with a density mode. It calculates the density of a solid using the weight of a sample in air and the weight in liquid.

- The density mode was not selected for use when the balance was shipped from the factory. To use the mode, change the function table and activate the density mode.
- Inputting order, of the parameters necessary for density measurement, can be changed.
- A part of the parameters can be changed and used for re-calculating the density. Press the **[SAMPLE]** key to confirm or select each parameter. The parameters are stored in non-volatile memory. Each time a part of the parameters are changed, the density can be re-calculated.
- Two ways to set the density of a liquid are available in the function table, "Liquid density input (l di n)": by entering the water temperature or by entering the density directly.
- When the density mode is selected, the response adjustment and self check function can not be used.

Formula to obtain the density

The density can be obtained by the following formula.

$$\rho = \frac{A}{A - B} \times \rho_0$$

- Where
- ρ : Density of a sample
 - A : Weight value of a sample in air
 - B : Weight value of a sample in liquid
 - ρ_0 : Density of a liquid

15-1-1. Prior to measurement: Changing the function table

Prior to measurement, change the function table as follows:

Step 1 Selecting the density mode.

The density mode is available as one of the weighing units. Select it by pressing the **[MODE]** key. To use the mode, select it (unit of **[Unit 15]**.) in the function table. For details, refer to "5-2. Changing the Units".

Step 2 Selecting a way to set the density of a liquid.

Select the liquid density input method from the function table below. The function table is available only when the density mode is selected.

| Class | Item and Parameter | Description |
|----------------------------|--------------------------------|-----------------------|
| d5 fnc Density function | l di n Liquid density input | ▪ 0 Water temperature |
| | | ▪ 1 Liquid density |

▪ : Factory setting.

15-1-2. Measuring the density

Note If the liquid temperature or the type of liquid is changed during measurement, input again the value of the liquid density as necessary. Refer to "C. Entering the density of a liquid".

Entering the density mode

- Step 1 Press the **MODE** key as necessary to select the density mode. When the density mode begins, "d-a" (weight in air), "g (gram)" for the unit and the processing indicator (◀) are turned on.
- Step 2 Selecting a parameter to set.
Press the **SAMPLE** key to select a parameter to set. Each pressing of the key switches the parameter.
Press the **RE-ZERO** key to enter the inputting mode of the parameter selected.

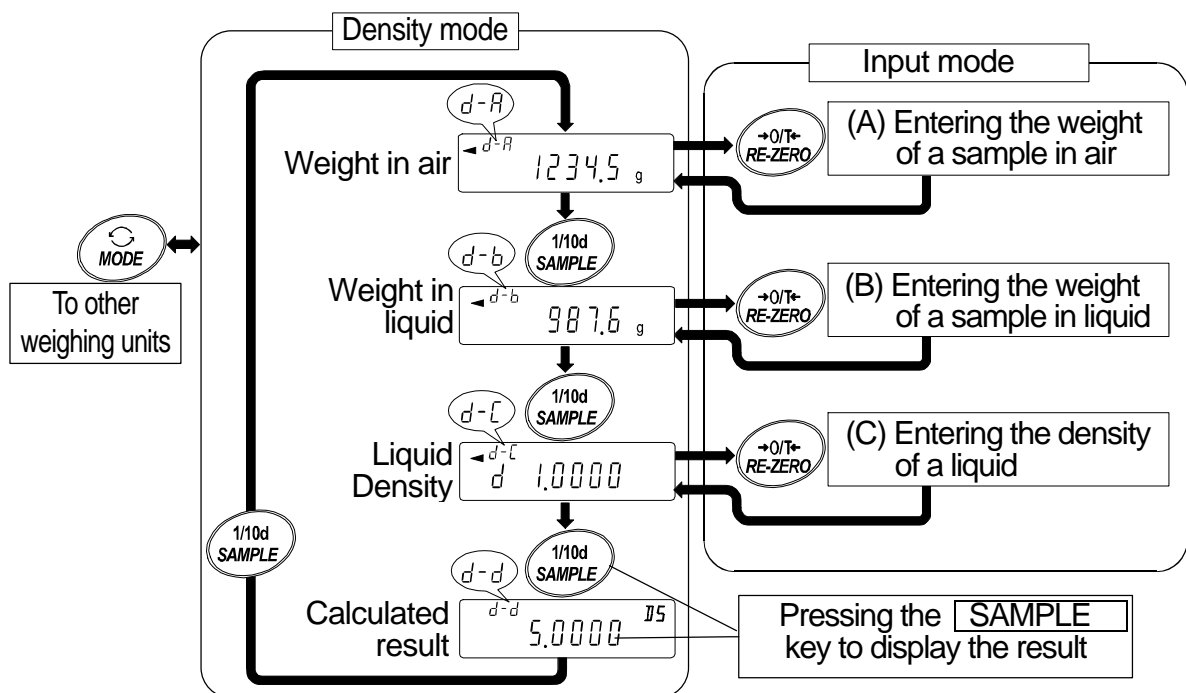

Setting the parameter

Step 3 Setting the parameter.

(A) Entering the weight of a sample in air

- 1 Confirm that nothing is placed on the upper pan (in air). Press the **RE-ZERO** key to set the display to zero.
- 2 Place a sample on the upper pan. When the value displayed on the balance becomes stable, press the **PRINT** key. The sample weight in air is confirmed and the balance will return to the density mode (Go to "Step 2 Selecting a parameter to set").
- 3 Remove the sample from the upper pan.

Note If an unstable value, a negative value or **e** (error) is displayed, the **PRINT** key is disabled. The **SAMPLE** key can not be used to change the minimum weighing value.

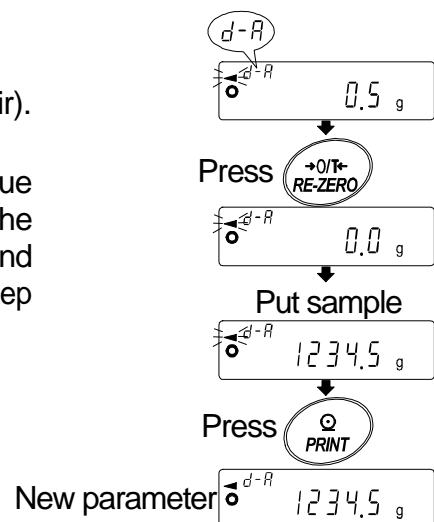

(B) Entering the weight of a sample in liquid

- 1 Confirm that nothing is placed on the lower pan (in liquid). Press the **RE-ZERO** key to set the display to zero.
- 2 Place a sample on the lower pan (in liquid). When the value displayed on the balance becomes stable, press the **PRINT** key. The sample weight in liquid is confirmed and the balance will return to the density mode (Go to "Step 2 Selecting a parameter to set").
- 3 Remove the sample from the lower pan.

Note If an unstable value, a negative value or **e** (error) is displayed, the **PRINT** key is disabled. The **SAMPLE** key can not be used to change the minimum weighing value.

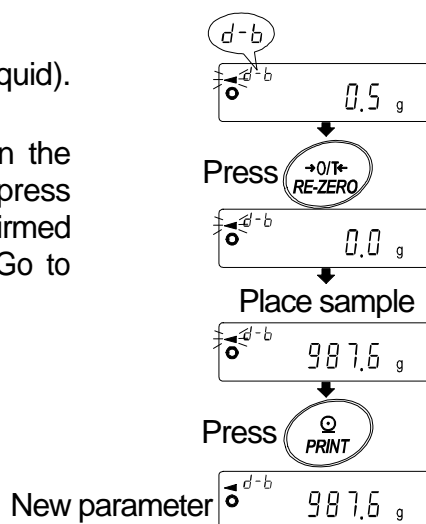

(C) Entering the density of a liquid

Two ways to set the density of a liquid are available in the function table, "Liquid density input (l di n): by entering the water temperature or by entering the density directly.

Entering the water temperature (l di n 0)

The water temperature currently set (unit:°C, factory setting : 25°C) is displayed.

Use the following keys to change the value.

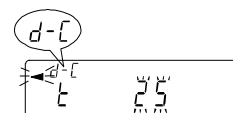

- RE-ZERO** key...To increase the temperature by one degree. (0°C is displayed after 99°C)
- MODE** keyTo decrease the temperature by one degree. (99°C is displayed after 0°C)
- PRINT** keyTo store the change, display **end** and return to the density mode. (Go to "Step 2 Selecting a parameter to set")
- CAL** key.....To cancel the change and return to the density mode. (Go to "Step 2 Selecting a parameter to set")

The relation between the water temperature and density is shown below.

| °C | +0 | +1 | +2 | +3 | +4 | +5 | +6 | +7 | +8 | +9 |
|----|---------|---------|---------|---------|---------|---------|---------|---------|---------|---------|
| 0 | 0.99984 | 0.99990 | 0.99994 | 0.99996 | 0.99997 | 0.99996 | 0.99994 | 0.99990 | 0.99985 | 0.99978 |
| 10 | 0.99970 | 0.99961 | 0.99949 | 0.99938 | 0.99924 | 0.99910 | 0.99894 | 0.99877 | 0.99860 | 0.99841 |
| 20 | 0.99820 | 0.99799 | 0.99777 | 0.99754 | 0.99730 | 0.99704 | 0.99678 | 0.99651 | 0.99623 | 0.99594 |
| 30 | 0.99565 | 0.99534 | 0.99503 | 0.99470 | 0.99437 | 0.99403 | 0.99368 | 0.99333 | 0.99297 | 0.99259 |
| 40 | 0.99222 | 0.99183 | 0.99144 | 0.99104 | 0.99063 | 0.99021 | 0.98979 | 0.98936 | 0.98893 | 0.98849 |
| 50 | 0.98804 | 0.98758 | 0.98712 | 0.98665 | 0.98618 | 0.98570 | 0.98521 | 0.98471 | 0.98422 | 0.98371 |
| 60 | 0.98320 | 0.98268 | 0.98216 | 0.98163 | 0.98110 | 0.98055 | 0.98001 | 0.97946 | 0.97890 | 0.97834 |
| 70 | 0.97777 | 0.97720 | 0.97662 | 0.97603 | 0.97544 | 0.97485 | 0.97425 | 0.97364 | 0.97303 | 0.97242 |
| 80 | 0.97180 | 0.97117 | 0.97054 | 0.96991 | 0.96927 | 0.96862 | 0.96797 | 0.96731 | 0.96665 | 0.96600 |
| 90 | 0.96532 | 0.96465 | 0.96397 | 0.96328 | 0.96259 | 0.96190 | 0.96120 | 0.96050 | 0.95979 | 0.95906 |

Entering the density directly (I di n 1)

The density currently set (unit : g / cm³, factory setting : 1.0000g / cm³) is displayed.

Use the following keys to change the value.

The range to set the density is 0.0000g / cm³ to 1.9999g / cm³.



RE-ZERO key... To set the value of the digit selected.

SAMPLE key... To select the digit to change the value.

PRINT key To store the change, display **end** and return to the density mode.
(Go to "Step 2 Selecting a parameter to set")

CAL key..... To cancel the change and return to the density mode.
(Go to "Step 2 Selecting a parameter to set")

Outputting the density.

Step 4 After all the necessary parameters have been set, press the **SAMPLE** key to output the density calculated.

The density is displayed with three decimal places.

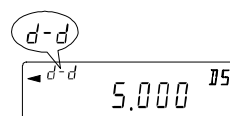

Calculated result

16. Standard Input & Output Interface

16-1. RS-232C And External Contact Input

D-Sub 25 pin numbers

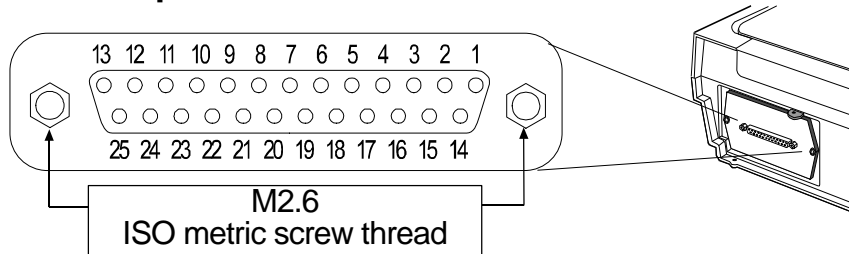

D-Sub 25 pin assignments

| Pin No. | Signal name | Interface type | Direction | Description |
|---------|-------------|----------------------------------|-----------|-------------------------|
| 1 | FG | | - | Frame ground |
| 2 | RXD | RS-232C | Input | Receive data |
| 3 | TXD | RS-232C | Output | Transmit data |
| 4 | RTS | RS-232C | Input | Ready to send |
| 5 | CTS | RS-232C | Output | Clear to send |
| 6 | DSR | RS-232C | Output | Data set ready |
| 7 | SG | RS-232C / external contact input | - | Signal ground |
| 18 | PRINT | External contact input | Input | Same as the PRINT key |
| 19 | RE-ZERO | External contact input | Input | Same as the RE-ZERO key |
| Others | - | - | - | No connection |

RS-232C

The balance is a DCE device. Connect the balance to a personal computer (DTE) using a straight through cable.

- Transmission system : EIA RS-232C
- Transmission form : Asynchronous, bi-directional, half duplex
- Transmission rate : 10 times/second or 5 times/second (same as data refresh rate)
- Data format : Baud rate : 600, 1200, 2400, 4800, 9600, 19200bps
- Data bits : 7 or 8 bits
- Parity : Even, Odd (Data bits 7 bits)
None (Data bits 8 bits)
- Stop bit : 1 bit
(When sending, 2 bits; receiving, 1 bit.
A personal computer will function with either setting.)
- Code : ASCII

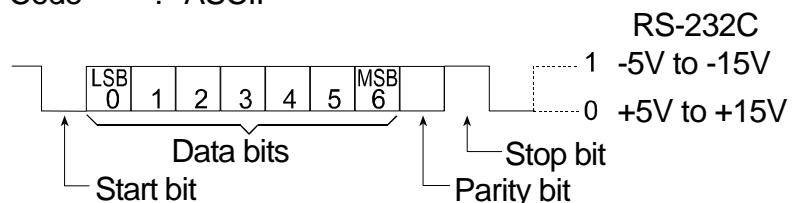

RS-232C Terminals

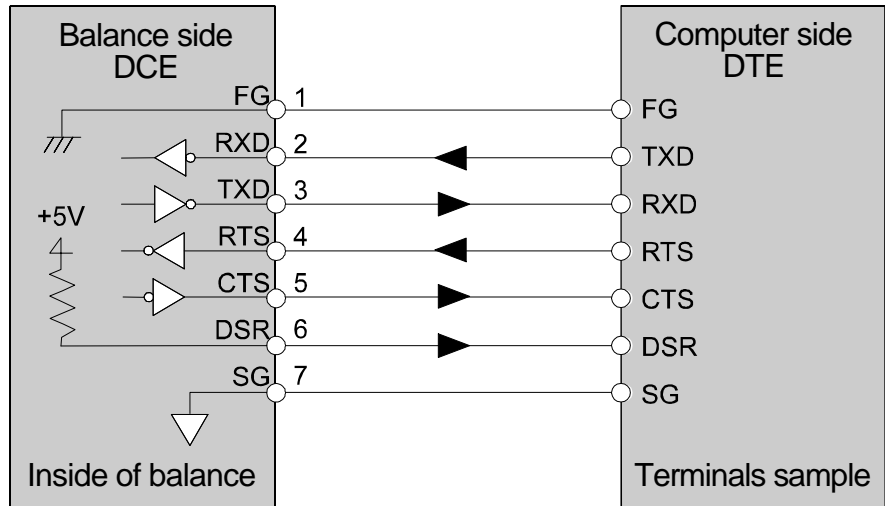

External contact input

By connecting pin 18 (PRINT command) to pin 7, or pin 19 (RE-ZERO command) to pin 7 for 100 ms or more, the same operation as performed by pressing the **PRINT** key or the **RE-ZERO** key, will be performed.

Example of foot switch

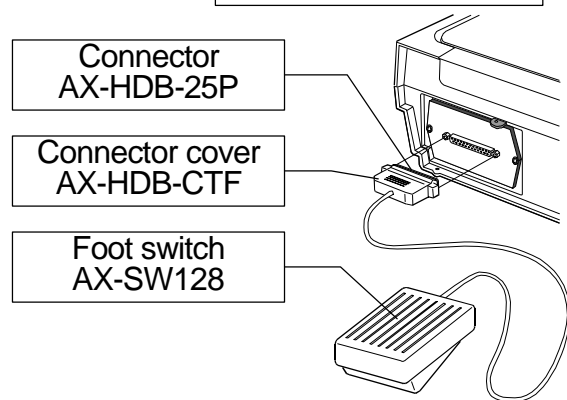

Accessory

- Connector : AX-HDB-25P/CTF
- Foot switch : AX-SW128

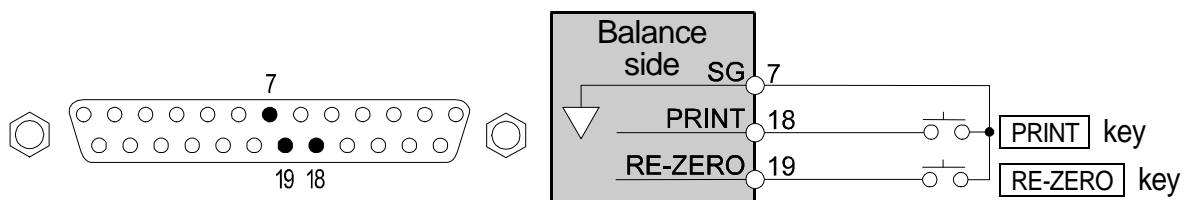

16-2. Connection to peripheral equipment

16-2-1. Connection To The AD-8121B Printer

Preset the following parameters to use the AD-8121B printer.

| Function setting | Description |
|------------------------------|---|
| dout prt 0 to 3 | Selects a print mode. |
| dout ap-p 0 to 2 | Selects the polarity for the auto print mode. |
| dout ap-b 0 to 2 | Selects the auto print difference. |
| dout pU5e 0,1 | Selects data output pause. |
| 5i f bp5 2 Factory setting | 2400 bps |
| 5i f btpr 0 Factory setting | 7 bits, Even parity check |
| 5i f Cr1 f 0 Factory setting | CR, LF |
| 5i f Ct5 0 Factory setting | Inhibit the use of CTS and RTS control |

When "MODE 1" or "MODE 2" of the AD-8121B printer is used

| Function setting | Description |
|-----------------------------|----------------------------------|
| dout 5-td 0 Factory setting | Not to output the time and date. |
| dout 5-id 0 Factory setting | Not to output the ID number. |
| dout at-f 0 Factory setting | Not to use auto feed. |
| 5i f type 0 Factory setting | A&D standard format |

When "MODE 3" of the AD-8121B printer is used.

| Function setting | Description |
|------------------|---|
| dout 5-td 0 to 3 | Outputs the time and date as necessary. |
| dout 5-id 0,1 | Outputs the ID number as necessary. |
| dout at-f 0,1 | Uses auto feed as necessary. |
| 5i f type 1 | DP format |

When data is transmitted continuously.

When all memory data is transmitted at one time.

| Function setting | Description |
|------------------|-------------|
| dout pU5e 1 | Uses pause. |

Notes

The printer performs as follows, depending on the data memory setting.

| Setting | Output data |
|---------|---|
| data 0 | The weighing data |
| data 2 | The weighing data stored in memory |
| data 3 | The calibration report stored in memory |

Refer to "11-2. GLP Report" for print samples.

- **GF-K series does not output the time and date. Use the calendar function of the AD-8121B.**
- **GF-K series does not store the calibration report in memory.**

16-2-2. Connection To A Computer And The Use Of WinCT

The balance is of the DCE type (Data Communication Equipment), which can be connected to a personal computer using the RS-232C interface. Before connection, read the personal computer manual thoroughly. Use a standard DCE cable for connection (cable type: straight-through). When the personal computer type is a DOS/V with a 9-pin port, use a straight-through cable with a 25-pin male connector and a 9-pin female connector.

Using Windows Communication Tools Software (WinCT)

When Windows is used as an operating system in a personal computer, the provided WinCT software can be used to transmit the weighing data to the personal computer.

The WinCT software has two communication methods: "RsCom" and "RsKey". Refer to the WinCT instruction manual.

RsCom

- RsCom can transmit commands to control the balance.
- RsCom can make bi-directional communication between the balance and a personal computer using the RS-232C interface.
- RsCom can display or store the data using a text file format. RsCom can also print the data using a printer connected to the personal computer.
- When several ports of a personal computer have balances connected, can communicate with each balance simultaneously.
- RsCom can share a personal computer with other application software.
- RsCom can receive the balance GLP report.

RsKey

- RsKey can transmit the weighing data output from the balance directly to other application software such as Microsoft Excel.
- RsKey can be used with most application software.
- RsKey can receive the balance GLP report.

Using the WinCT software, the balance can do the following:

- **Analyzing the weighing data and the statistics with "RsKey"**
The weighing data can be input directly into an Excel worksheet. Then, Excel can analyze the data to obtain total, average, standard deviation, maximum and minimum value, and display them in a graph.
- **Controlling the balance using commands from a personal computer**
By using "RsCom", the personal computer sends commands such as "re-zero" or "send weighing data" to the balance and controls the balance.
- **Printing the balance GLP report using your printer**
The balance GLP report can be printed using a printer connected to the personal computer.
- **Receiving weighing data at a certain interval**
The weighing data can be received at a certain interval and data characteristic with elapsed time can be obtained.
- **Using the balance memory function**
The data can be stored in the balance's memory. Of the data stored, the weighing data and calibration data can be transmitted to a personal computer at one time.
- **Using a personal computer as an external indicator**
With the "RsKey" test mode function, a personal computer can be used as an external weight indicator for the balance. (To do this, set the balance data output mode to stream mode.)

17. Commands

17-1. Command List

Note A command has a terminator added, that is specified using "5i f CrI f" of the function table, and is sent to the balance.

| Commands to query weighing data | |
|---------------------------------|---|
| C | Cancels the S or SIR command. |
| Q | Requests the weighing data immediately. |
| S | Requests the weighing data when stabilized. |
| SI | Requests the weighing data immediately. |
| SIR | Requests the weighing data continuously. |

| Commands to control the balance | |
|---------------------------------|---|
| ?CN | Requests the upper/lower limit value code number of the selected value. |
| ?HI | Requests the upper limit value. |
| ?ID | Requests the identification number. |
| ?LO | Requests the lower limit value. |
| ?MA | Outputs all weighing data in memory. |
| ?MQnnn | Outputs data with the data number nnn. nnn: Three digits |
| ?MX | Outputs the number of data in memory (the last data number) |
| ?PN | Request the tare number of the selected value. |
| ?PT | Request the tare value. |
| ?SN | Request the serial number of the balance. |
| ?TN | Request the model name of the balance. |
| ?UN | Requests the unit mass numbers in memory. |
| ?UW | Requests the unit mass value. |
| CAL | Same as the <u>CAL</u> key. |
| CN:mm | Recalls the upper/lower limit value in memory. mm: 01 to 20. |
| HI:??????.?~g | Sets the upper limit values. ~ is space mark. Example: the upper limit value is 2000.0 g. Command: HI:+002000.0~g |
| ID:??????? | Sets identification number. |
| LO:??????.?~g | Sets the lower limit values. ~ is space mark. Example: the lower limit value is 1000.0 g. Command :LO:+001000.0~g |
| MCL | Deletes all data in memory. |
| MD:nnn | Deletes data with the data number nnn. nnn: Three digits. |
| OFF | Turns the display off. |
| ON | Turns the display on. |
| P | Same as the <u>ON:OFF</u> key |
| PN:mm | Recalls the tare value in memory. mm: 01 to 20. |
| PRT | Same as the <u>PRINT</u> key |
| PT:?????.?~g | Sets the tare value. ~ is space mark. Example: the tare value is 1000.0 g. Command :PT:+001000.0~g |

| Commands to control the balance | |
|---------------------------------|---|
| R | Same as the RE-ZERO key |
| SMP | Same as the SAMPLE key. |
| U | Same as the MODE key |
| UN: mm | Recalls the unit mass values in memory. mm: 01 to 50. |
| UW: ??????.?~g | Changes the unit mass value. Use "g" of unit. ~ is space mark. Example: the unit mass value is 2000.0 g. Command: UW: +002000.0~g |

When a unit is required in commands such as a "PT:" command, use the 3-digit unit code of the A&D standard format.

nnn indicates a three-digit numerical value.

17-2. Acknowledge Code And Error Codes

When the "Serial interface function (5i f)" parameter is set to "erCd 1", the balance outputs <AK> code or error code to each command as follows:

<AK> (06h) Acknowledge in ASCII code.

- When the balance receives a command to request data and can not process it, the balance transmits an error code (EC, E_{xx}).

When the balance receives a command to request data and can process it, the balance outputs the data.

- When the balance receives a command to control the balance and can not process it, the balance transmits an error code (EC, E_{xx}).

When the balance receives a command to control the balance and can process it, the balance transmits the acknowledge code.

Among commands to control the balance, the following transmit the acknowledge code both when the balance receives the command and when the balance has accomplished the command. If the command can not be processed properly, the balance transmits an error code (EC, E_{xx}). This error can be released using the CAL command.

CAL command (Calibration command using internal mass)

ON command (Display ON command)

P command (Display ON/OFF command)

R command (RE-ZERO command)

- When a communication error has occurred due to external noise, or a parity error has occurred due to transmission error, the balance transmits an error code. In this case, send the command again.

xx is error code number.

17-3. Control Using CTS And RTS

Depending on the "Ct5" parameter of "Serial interface (5i f)", the balance performs as follows:

Ct5 0

Regardless of whether the balance can receive a command or not, the balance keeps the CTS line Hi. The balance outputs data regardless of the condition of the RTS line.

Ct5 1

The CTS line is kept Hi normally. When the balance can not receive the next command (Example: while the balance is processing the last command), the balance sets the CTS line to Lo. The balance confirms the level of the RTS line before outputting a set of data. If the RTS level is Hi, the balance outputs data. If the RTS level is Lo, data is not output (The data is canceled).

17-4. Settings Related To RS-232C

Concerning the RS-232C, the balance has two functions: "Data output (dout)" and "Serial interface (5i f)". Set each function as necessary.

18. Maintenance

18-1. Treatment Of The Balance

- In normal use, the balance can be cleaned with water. But, keep the following precautions so that dust and water do not invade the balance.
 - Do not direct water pressure at the bottom of the balance.
 - Do not use powerful water jets.
 - Do not submerge the balance in water.
- Clean the balance with a lint free cloth that is moistened with warm water and a mild detergent.
- Do not use organic solvents to clean the balance.
- Do not disassemble the balance. Contact the local A&D dealer if the balance needs service or repair.
- Use the original packing material for transportation.
- While cleaning the balance and keeping it waterproof, connect a waterproof RS-232C cable (GX-07K) or cover terminals of the RS-232C interface and AC adapter jack. Insure that the underhook cover is in place.
- The value of the internal mass may change due to aging, corrosion or other damage caused by the operating environment. Check the internal mass periodically. Correct the internal mass value as necessary.

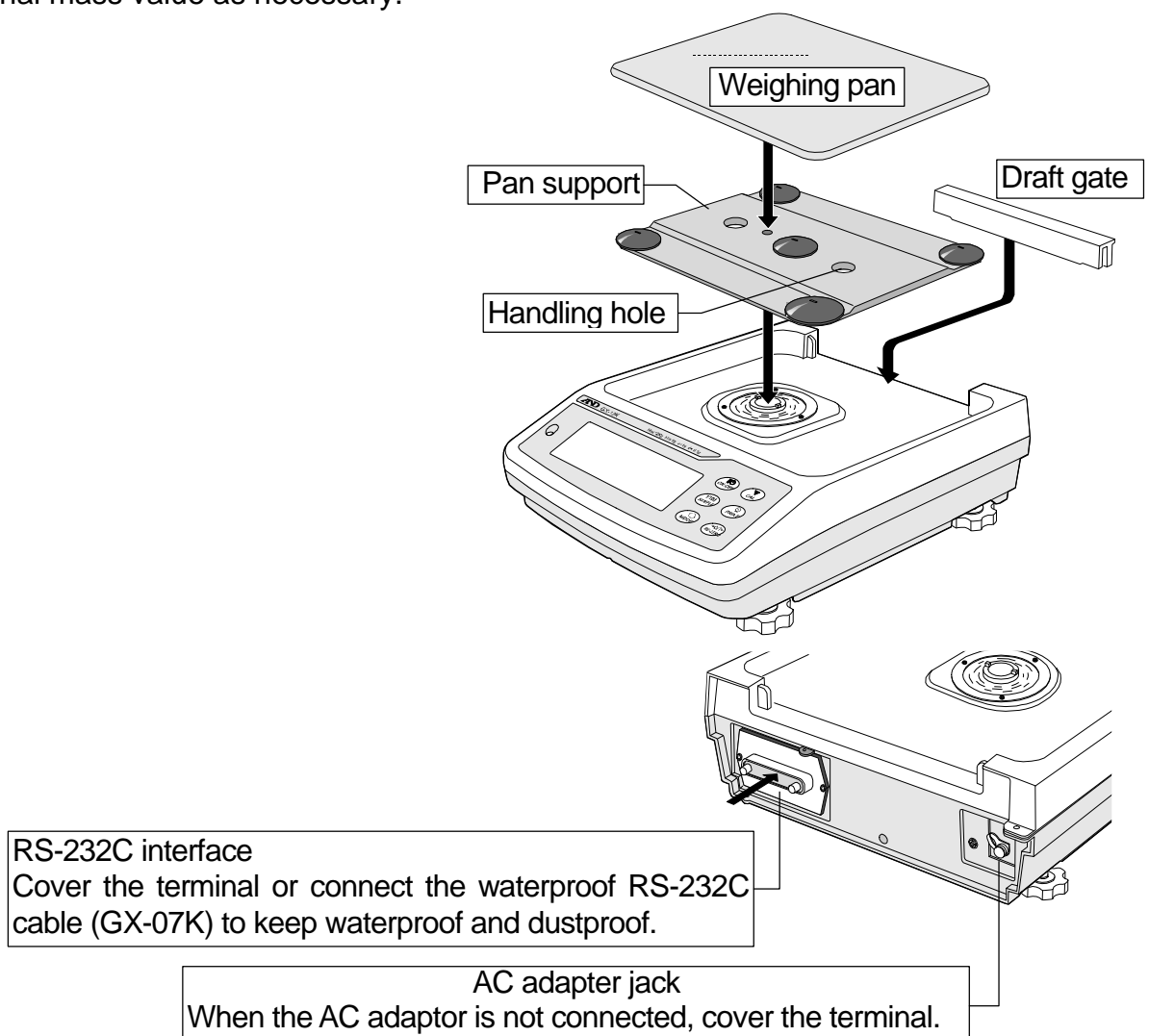

19. Troubleshooting

19-1. Checking The Balance Performance And Environment

The balance is a precision instrument. When the operating environment or the operating method is inadequate, correct weighing can not be performed. Place a sample on the pan and remove it, and repeat this several times. If the balance seems to have a problem with repeatability or to perform improperly, check as described below. If improper performance persists after checking, contact the local A&D dealer for repair.

Checking that the balance performs properly

- Check the balance performance using the self-check function as described in "7. Weighing Speed Adjustment / Self Check Function".
An error display appears when a malfunction is found.
- Check the balance repeatability using an external weight. Be sure to place the weight in the center of the weighing pan.
- Check the balance repeatability, linearity and calibrated value using external weights with a known value.

Checking that the operating environment or weighing method is proper

Operating environment

- Is the weighing table solid enough?
- Is the balance level? Refer to "3-1. Before Use".
- Is the operating environment free from vibration and drafts?
- Is there a strong electrical or magnetic noise source such as a motor near the balance?





Weighing method

- Does the weighing pan touch the rim or anything? Is the weighing pan and pan support installed correctly?
- Is the **RE-ZERO** key pressed before placing a sample on the weighing pan?
- Is the sample placed in the center of the weighing pan?
- Has the balance been calibrated using the internal mass (one-touch calibration)?
- Has the balance been warmed up for 30 minutes before weighing?

Sample and container

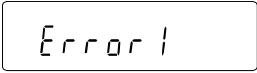
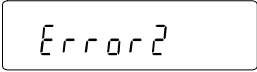
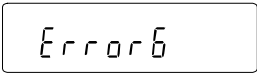
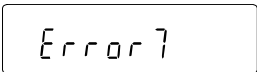
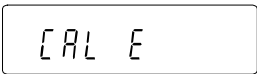
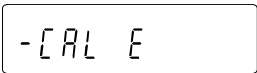
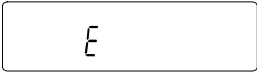
- Has the sample absorbed or lost moisture due to the ambient conditions such as temperature and humidity?
- Has the temperature of the container been allowed to equalize to the ambient temperature? Refer to "3-2. During Use".
- Is the sample charged with static electricity? Refer to "3-2. During Use".
- Is the sample of magnetic material such as iron? Caution is required for weighing magnetic materials. Refer to "3-2. During Use".

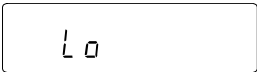
19-2. Error Codes

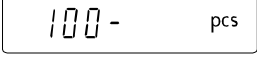
| Display | Error code | Description |
|---|------------|--|
|  | EC, E11 | Stability error The balance can not stabilize due to an environmental problem. Check around the pan. Refer to "3. Precautions". Prevent vibration, drafts, temperature changes, static electricity and magnetic fields, from influencing the balance. To return to the weighing mode, press the [CAL] key. |
|  | | Out of the setting range The data to be stored is out of the setting range. |
|  | EC, E16 | Internal mass error Applying the internal mass does not yield a change in the weight value as specified. Confirm that there is nothing on the pan and perform the weighing operation from the beginning again. |
|  | EC, E17 | Internal mass error The internal mass application mechanism does not function properly. Perform the weighing operation from the beginning again. |
|  | EC, E20 | Calibration weight error The calibration weight is too heavy. Confirm the calibration weight value. Press the [CAL] key to return to the weighing mode. |
|  | EC, E21 | Calibration weight error The calibration weight is too light. Confirm the calibration weight value. Press the [CAL] key to return to the weighing mode. |
|  | | Overload error A sample beyond the balance weighing capacity has been placed on the pan. Remove the sample from the pan. |
|  | | Weighing pan Error The weight value is too light. Confirm that the weighing pan is properly installed and calibrate the balance. |
|  | | Sample mass error The balance can not store the sample for the counting mode or for the percent mode because it is too light. Use a larger sample. |
|    | | Unit mass error The sample unit mass for the counting mode is too light. Storing and using it for counting will cause a counting error. Add samples to reach the specified number and press the [PRINT] key. Pressing the [PRINT] key without adding samples will shift the balance to the counting mode. But, to acquire accurate weighing, be sure to add samples. |

| Display | Error code | Description |
|-------------------|------------|--|
| | | Automatic response adjustment zero error The automatic response adjustment can not be performed because there is something on the pan. Clear the pan. Press the [CAL] key to return to the weighing mode. |
| (Check NG) | | Automatic response adjustment unstable error The automatic response adjustment can not be performed because the weight value is unstable. Check the ambient conditions such as breeze, vibration and magnetic fields, also check the weighing pan. Press the [CAL] key to return to the weighing mode. |
| (Check no) | | Internal error This error indicates an internal error as the result of self-check function. Repair is required. Contact the local A&D dealer. |
| | | Clock battery error The clock backup battery has been depleted. Press any key and set the time and date. The clock and calendar function works normally as long as the AC adapter is connected to the balance. If this error appears frequently, contact the local A&D dealer. |
| (Blinking) | | Memory full The amount of weighing data in memory has reached the maximum capacity. Delete data in memory to store new data. For details, refer to "12. Data Memory". |
| (Illuminated) | | Memory full The amount of calibration or calibration test data in memory has reached the maximum capacity (50 sets). The data in memory will be deleted automatically to store new data. For details, refer to "12. Data Memory". |
| | | Memory type error Type of memory set in the function table and type of data stored are different. For details, refer to "12. Data Memory". |
| | EC, E00 | Communications error A protocol error occurred in communications. Confirm the format, baud rate and parity. |
| | EC, E01 | Undefined command error An undefined command was received. Confirm the command. |
| | EC, E02 | Not ready A received command can not be processed. Example: <ul style="list-style-type: none"> □ The balance received a "Q" command, but not in the weighing mode. □ The balance received a "Q" command while processing a RE-ZERO command. Adjust the delay time to transmit a command. |

| Display | Error code | Description |
|------------------|------------|---|
| | EC, E03 | Timeout error If the timeout parameter is set to "t-Up1", the balance did not receive the next character of a command within the time limit of one second. Confirm the communication. |
| | EC, E04 | Excess characters error The balance received excessive characters in a command. Confirm the command. |
| | EC, E06 | Format error A command includes incorrect data. Example: □ The data is numerically incorrect. Confirm the command. |
| | EC, E07 | Parameter setting error The received data exceeds the range that the balance can accept. Confirm the parameter range of the command. |
| Other error code | | If an error described above can not be released or other errors are displayed, contact the local A&D dealer. |

19-3. Other Display



When this indicator blinks, automatic self calibration is required. The indicator blinks when the balance detects changes in ambient temperature. If the balance is not used for several minutes with this indicator blinking, the balance performs automatic self calibration. The blinking period depends on the operating environment.

Advise The balance can be used while this indicator is blinking. We recommend that you perform automatic self calibration for precision weighing.

19-4. Asking For Repair

If the balance needs service or repair, contact your local A&D dealer.

The balance is a precision instrument. Use much care when handling the balance and observe the following when transporting the balance.

- Use the original packing material for transportation.
- Remove the draft gate, weighing pan and pan support from the main unit before placing the balance in the shipping container..

20. Specifications

| | GX-8K | GX-8K2 | GX-12K | GX-20K | GX-30K | GX-32K |
|---|--|--|-------------|--------------|--------------|--------------|
| Weighing capacity | 8.1 kg | 8.1 kg | 12 kg | 21 kg | 31 kg | 31 kg |
| Maximum display | 8.10084 kg | 8.1008 kg | 12.0084 kg | 21.0084 kg | 31.0084 kg | 31.008 kg |
| | | 2.10009 kg *1 | | | | 6.1009 kg *1 |
| Minimum weighing value (1 digit) | 0.01 g | 0.1 g / 0.01 g | 0.1 g | | | 1g / 0.1 g |
| Repeatability (Standard deviation) | 0.01 g | 0.05 g / 0.01g | 0.1 g | | | 0.5g / 0.1 g |
| Linearity | ±0.02 g | ±0.1 g / ±0.02 g | ±0.2 g | | | ±1g / ±0.2 g |
| Stabilization time (Typical at FAST) | Approx. 1.5 seconds | | | | | |
| Sensitivity drift, (10°C ~ 30°C / 50°F ~ 86°F) *2 | ±2 ppm/°C | ±3 ppm/°C | | | | ±5 ppm/°C |
| Accuracy right after calibration using the internal mass (Accuracy of full scale) *3 | ±0.15 g | ±0.3 g | ±1.0 g | | ±1.5 g | ±3 g |
| Operating environment | 5°C to 40°C (41°F to 104°F), 85%RH or less (No condensation) | | | | | |
| Internal mass | Built-in function | | | | | |
| Weighing data of data memory | 200 data, 100 data with calendar | | | | | |
| Time and clock function | Built-in function | | | | | |
| Display refresh rate | 5 times/second or 10 times/second | | | | | |
| Counting mode | Minimum unit mass | 0.01 g | 0.1 g | | | 1g |
| | Number of samples | 10, 25, 50 or 100 pieces | | | | |
| Percent mode | Minimum 100% reference mass | 1 g | 10 g | | | 100g |
| | Minimum 100% display | 0.01 %, 0.1 %, 1 % (Depends on the reference mass stored.) | | | | |
| Interface (Provided as standard) | RS-232C with Windows Communication Tools Software WinCT | | | | | |
| External calibration weight | 2 kg, 3 kg, 4 kg, 5 kg, 6 kg, 7 kg, 8 kg | | 5 kg, 10 kg | 10 kg, 20 kg | 20 kg, 30 kg | |
| Weighing pan | 270 x 210 mm | | | | | |
| External dimensions | 300(W) x 355(D) x 111(H) mm | | | | | |
| Power supply & AC adapter type | Power consumption: Approx. 11VA (supplied to the AC adapter) Confirm that the adapter type is correct for the local voltage and power receptacle type. | | | | | |
| Weight | Approx. 9.3kg | | | | | |
| Dust and water protection | Complying with IP65 | | | | | |

*1: The balance allows weighing using a precision range, even with a heavy tare placed on the pan. (Smart range function)

*2: When automatic self calibration is not used.

*3: Accuracy right after calibration using the internal mass in good ambient conditions (within the temperature range of 10°C to 30°C (50°F to 86°F) with no abrupt changes in temperature or humidity, no drafts, no effect by magnetic fields or static electricity).

□ Check the internal mass periodically as described in "18. Maintenance".

| | GF-8K | GF-8K2 | GF-12K | GF-20K | GF-30K | GF-32K |
|---|--|--|-------------|--------------|--------------|---------------|
| Weighing capacity | 8.1 kg | 8.1 kg | 12 kg | 21 kg | 31 kg | 31 kg |
| Maximum display | 8.10084 kg | 8.1008 kg | 12.0084 kg | 21.0084 kg | 31.0084 kg | 31.008 kg |
| | | 2.10009 kg *1 | | | | 6.1009 kg *1 |
| Minimum weighing value (1 digit) | 0.01 g | 0.1 g / 0.01 g | 0.1 g | | | 1 g / 0.1 g |
| Repeatability (Standard deviation) | 0.01 g | 0.05 g / 0.01 g | 0.1 g | | | 0.5 g / 0.1 g |
| Linearity | ±0.02 g | ±0.1 g / ±0.02 g | ±0.2 g | | | ±1 g / ±0.2 g |
| Stabilization time (Typical at FAST) | Approx. 1.5 seconds | | | | | |
| Sensitivity drift, (10°C ~ 30°C / 50°F ~ 86°F) | ±2 ppm/°C | ±3 ppm/°C | | | | ±5 ppm/°C |
| Operating environment | 5°C to 40°C (41°F to 104°F), 85%RH or less (No condensation) | | | | | |
| Internal mass | not available | | | | | |
| Weighing data of data memory | 40 data | | | | | |
| Time and clock function | not available | | | | | |
| Display refresh rate | 5 times/second or 10 times/second | | | | | |
| Counting mode | Minimum unit mass | 0.01 g | 0.1 g | | | 1g |
| | Number of samples | 10, 25, 50 or 100 pieces | | | | |
| Percent mode | Minimum 100% reference mass | 1 g | 10 g | | | 100g |
| | Minimum 100% display | 0.01 %, 0.1 %, 1 % (Depends on the reference mass stored.) | | | | |
| Interface (Provided as standard) | RS-232C with Windows Communication Tools Software WinCT | | | | | |
| External calibration weight | 2 kg, 3 kg, 4 kg, 5 kg, 6 kg, 7 kg, 8 kg | | 5 kg, 10 kg | 10 kg, 20 kg | 20 kg, 30 kg | |
| Weighing pan | 270 x 210mm | | | | | |
| External dimensions | 300(W) x 355(D) x 111(H) mm | | | | | |
| Power supply & AC adapter type | Power consumption: Approx. 11VA (supplied to the AC adapter) Confirm that the adapter type is correct for the local voltage and power receptacle type. | | | | | |
| Weight | Approx. 8.3kg | | | | | |
| Dust and water protection | Complying with IP65 | | | | | |

*1: The balance allows weighing using a precision range, even with a heavy tare placed on the pan. (Smart range function)

20-1.External Dimensions

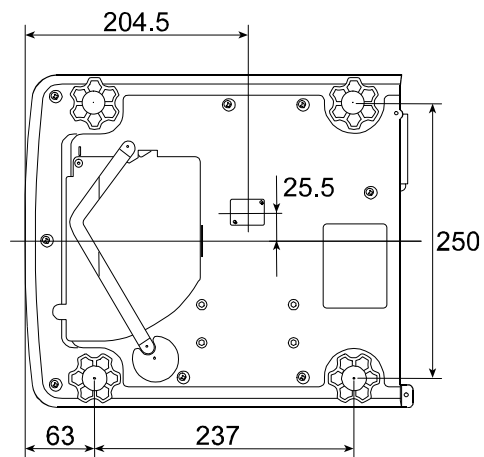
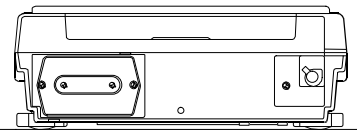
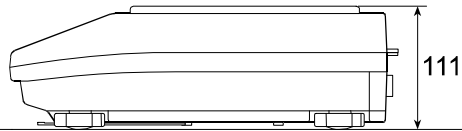
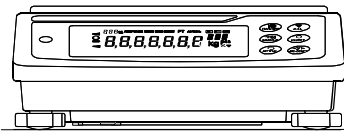
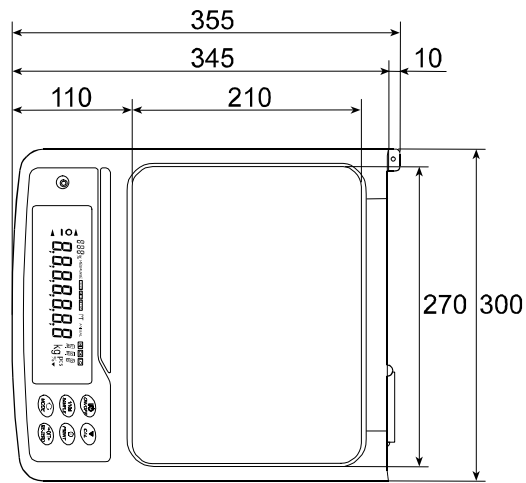

Unit: mm

20-2.Options and Peripheral Instruments

AD-8121B Printer

- Compact dot-matrix printer
- Statistical function, clock and calendar function, interval print function, graphic print function, dump print mode
- 5 x 7 dots, 16 characters per line
- Print paper (AX-PP143, 45 (W) x 50 (L) mm , ø65 mm)
- AC adapter or alkaline battery

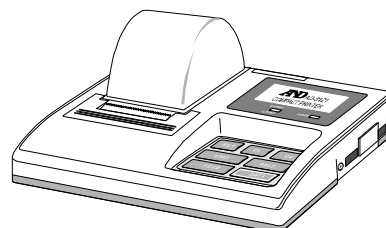

Options

| Order code | Name and description |
|------------|---|
| GX-04K | <p>Comparator Output (Relay/ with a Buzzer) / RS-232C / Current Loop</p> <ul style="list-style-type: none"> □ This option generates a relay output corresponding to HI , OK and LO in the display. □ Current loop and RS-232C can be used at the same time. For example, a personal computer and an AD-8121B printer can be used simultaneously. □ This option is installed in place of the standard RS-232C serial interface. |
| GX-06K | <p>Analog Voltage Output / Current Loop</p> <ul style="list-style-type: none"> □ This option outputs a voltage of 0 to1V (or 0.2 to1V) depending on the displayed value. □ With this option, current loop can be used. For example, an AD-8121B printer can be used simultaneously using this option. □ This option is installed in place of the standard RS-232C serial interface. So, RS-232C is not available for use. |
| GX-07K | <p>Waterproof and Dustproof RS-232C Cable</p> <ul style="list-style-type: none"> □ Length 5m, straight type, D-sub 9pin - D-sub 25pin. □ 25pin of balance side is only waterproof type. |

Note When option GX-04K or GX-06K is installed in the balance, the balance does not comply with IP-65 (waterproof and dustproof).

Accessories

| Order code | Name and description |
|---------------|---|
| AD-1682 | Rechargeable Battery <ul style="list-style-type: none"> □ This option allows use of the balance in a place where AC power is not available. |
| AD-8524A/B | Keyboard Adapter <ul style="list-style-type: none"> □ This option can be used to connect the balance to a personal computer with appropriate OS and applications. |
| AD-8920 | Remote Display <ul style="list-style-type: none"> □ This option can be connected to the balance using the RS-232C interface. |
| AX-GXK-31 | Breeze break |
| AX-KO1710-200 | RS-232C Cable <ul style="list-style-type: none"> □ Length 2m, straight type, D-sub 9pin - D-sub 25pin. |
| AX-SW128 | Foot Switch <ul style="list-style-type: none"> □ This option is used to externally transmit a RE-ZERO or PRINT signal to the balance. |















21. Terms/Index

21-1. Terms

| | |
|----------------------|--|
| Calibration | Adjustment of the balance so that it can weigh accurately. |
| Calibration weight | A weight used for calibration |
| Data number | Numbers assigned sequentially when weighing data or unit weight is stored. |
| Digit | The minimum weighing value available. Used for the balance, one digit is the smallest mass that can be displayed. |
| Environment | Ambient conditions such as vibration, drafts, temperature, static electricity and magnetic fields which affect the weighing operation. |
| External weight | The weight that you have. |
| GLP | Good Laboratory Practice. |
| Internal mass | Built-in calibration weight |
| IP-65 | IP code: Degree of protection provided by enclosures. 6: Dust-tight. No ingress of dust. 5: Protect against water jets. |
| Mode | Balance operational function. |
| Output | To output the weighing data using the RS-232C interface. |
| Range | A combination of weighing range and resolution. |
| Repeatability | Variation in measured values obtained when the same mass is placed and removed repetitively. Usually expressed as a standard deviation. Example: Standard deviation = 1 digit: This means that measured values, obtained when the same sample is placed and removed repetitively, fall within ± 1 digit in the frequency of about 68%. |
| Re-zero | To set the display to zero. |
| Sensitivity drift | An affect that a change in temperature causes to the weighing data. Expressed as a temperature coefficient. Example: Temperature coefficient = 2 ppm/ $^{\circ}$ C : If a load is 8 kg and the temperature changes by 10 $^{\circ}$ C, the value displayed changes by the following value. $0.0002\%/^{\circ}\text{C} \times 10^{\circ}\text{C} \times 8 \text{ kg} = 0.16 \text{ g}$ In this example, if the value displayed is 8000.00 g before temperature changes, a temperature change of 10 $^{\circ}$ C will make the value displayed 8000.16 g. |
| Smart range function | The function allows weighing in the precision range, even if a heavy tare is used. |

| | |
|--------------------|--|
| Stable value | The stable weight data, indicated by the illuminated stabilization indicator. |
| Stabilization time | Time required after a sample being placed, until the stabilization indicator illuminates and the weighing data is displayed. |
| Store | To save the weighing data, unit mass or calibration data using the data memory function. |
| Tare | To cancel the weight of a container which is not to be included in the weighing data. Normally, refers to an operation of placing a container and setting the display to zero. |
| Target weight | An external weight used for calibration test |
| Zero point | A weighing reference point. Usually refers to the value displayed when nothing is on the weighing pan. |

21-2. Index

- % Unit of percent mode 18
 CAL key 9
 MODE key 9
 ON/OFF key 9
 PRINT key 9
 RE-ZERO key 9, 32
 SAMPLE key 9, 32
 ANIMAL Animal indicator 9
 Calibration will start 9, 24
 Capacity indicator 9
 Data number 9
 Interval memory mode 9
 Mode standby 9
 Process indicator 9, 24
 ~ Space mark 42, 52, 53, 54
 Stabilization indicator 9, 15, 32
 Standby indicator 9
 RESPONSE **FAST** MID SLOW Weighing speed 9, 21

 A&D format 39
 AC adapter 6
 ACAI Function 17
 Accessory 87
 AD-1682 94
 AD-8121B Printer 80, 93
 AD-8524 94
 AD-8920 94
 add add 33, 37
 AK code 83
 ap-b Auto print difference 34, 38
 ar-d Zero after output 35
 ap-p Auto print polarity 34, 38
 at-f Auto feed 35
 AX-KO1710-200 94
 AX-SW128 94
 ba5fnc Environment display 33
 bep- LO buzzer 33
 bep- OK buzzer 33
 bep- HI buzzer 33
 bp5 Baud rate 35
 btpr Data bit, parity bit 35
 -Cal e Calibration weight error 87
 Cal e Calibration weight error 87
 Cal i n One-touch calibration 25
 Cal out Calibration using an external weight 26
 Cal . Automatic self calibration 24
 Calibration 23, 27, 95
 Calibration test 23
 Calibration weight 23
 CC out Calibration test 27

 CH 0 Response error 88
 CH ng Check NG 22
 CH no Check NO 22
 Cl adj Clock 33
 Cl r Initializing the balance 31
 Cond Condition 33, 36
 Cp Comparator mode 33, 55
 Cp fnc Comparator 33
 Cp Hi Upper limit 34
 Cp i n Data input method 33
 Cp l mt Tolerance 34, 47
 Cp l o Lower limit 34
 Cp ref Reference value 34
 Cp-b Main display comparison 33
 Cp-r Comparison results 33
 Cr l f Terminator 35
 C5 i n Internal mass correction 35
 CSV format 40
 Ct5 CTS, RTS control 35
 CTS 84
 -d- Weighing data with calendar 55
 data Data memory 34
 Data number 95
 Digit 95
 d-no Data number output 34
 dout Data output 34, 38
 d5 fnc Density function 35
 Density unit 74
 d-t Weighing data 55
 Dump print 39
 -e Weighing pan Error 87
 e Overload error 87
 EC,E00 Communications error 88
 EC,E01 Undefined command error 88
 EC,E02 Not ready 88
 EC,E03 Timeout error 88
 EC,E04 Excess characters error 89
 EC,E06 Format error 89
 EC,E07 Parameter setting error 89
 EC,E11 Stability error 87
 EC,E16 Internal mass error 87
 EC,E17 Internal mass error 87
 EC,E20 Internal mass error 87
 EC,E21 Internal mass error 87
 erCd AK, Error code 35
 error 1 Stability error 87
 error 2 Out of the setting range 87
 error 6 Internal mass error 87
 error 7 Internal mass error 87
 Error code 87
 External weight 23, 24, 95
 FAST 21
 fUl Memory full 88
 g5i Capacity indicator 33, 37
 GX-04K 93
 GX-06K 93

| | | | | | |
|------------------|--------------------------------|--------------|----------------------|-----------------------------------|--------------|
| GX-07K | | 93 | Repeatability | | 95 |
| Hi 5 | Calibration result | | Re-zero | | 95 |
| Hold | Hold function | 33, 36 | rng | Display at start..... | 33, 37 |
| id | ID number setting | | RsCom | | 81 |
| ID Number | | 51 | RsKey | | 81 |
| info | GLP output | | rtc | Clock battery error | 88 |
| int | Interval time | | RTS | | 84 |
| Internal mass | | 23 | 5-id | ID number output | 34 |
| KF format | | 40 | 5if | Serial interface | 35 |
| ldin | Liquid density input | | SLOW | | 21 |
| lo | Sample mass error | | Smart range function | | 10, 95 |
| MID. | | 21 | 5pd | Display refresh rate..... | 33, 37 |
| mlt | Programmable-unit (Multi-unit) | | Stabilization time | | 96 |
| Mode | | 95 | Stable value | | 96 |
| MT format | | 40 | 5start | Title block..... | 54 |
| Numerical format | | 40 | 5t-b | Stability band width | 33, 36 |
| Option | | 93 | 5-td | Time/Date output..... | 34 |
| out | Report output | | Store | | 96 |
| p01-p20 | Unit mass number | | t01-t20 | Tare value | 66 |
| p01-p50 | Unit mass number | | Tare | | 96 |
| p5 | internal mass correction | | Target weight | | 23, 96 |
| pC | Unit mass of data memory | | tr | Tare value | 55 |
| pnt | Decimal point | 33, 37 | trc | Zero tracking | 33, 37 |
| poFF | Auto display-OFF | 33, 37 | t-Up | Timeout..... | 35 |
| p-on | Auto display-ON | | type | Data format..... | 35 |
| prt | Data output mode | 34, 38 | PCS | Unit of counting mode..... | 16 |
| pU5e | Data output pause | | Unit | Unit | 35 |
| Range | | 95 | WinCT | Communication Tools Software..... | 81 |
| recend | End block | | Zero point | | 96 |

