

Micro Analytical Balances

BM

Series

BM-20

22 g × 0.001 mg (1 µg)

BM-22 (Smart range)

22 g × 0.01 mg

5.1 g × 0.001 mg (1 µg)

BM-252

250 g × 0.01 mg

BM-200

220 g × 0.1 mg

BM-300

320 g × 0.1 mg

BM-500

520 g × 0.1 mg



Built-in Fanless Ionizer!



AND

A&D Company, Limited

<http://www.aandd.jp>

...Clearly a Better Value

How to Eliminate the Greatest Enemy of Precision Weighing

Static electricity, while often overlooked, can be a fatal source of error in precise weight measurements. With the BM Series, A&D seek in various ways to help you perform sometimes-tricky analytical weighing with simplicity and accuracy, including the elimination of static electricity. The world of micro grams (μg) is now accessible to all researchers!

Errors due to static electricity

An electrostatically charged object induces the opposite charge in nearby objects. The attraction between the two charges causes an inaccurate value.

1

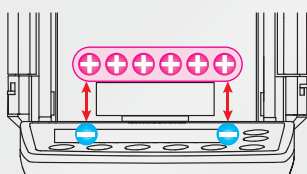

Error when weighing a charged object

The value will be shifted in the positive direction. It then gradually changes as static electricity is discharged into the air or via the weighing pan.

2

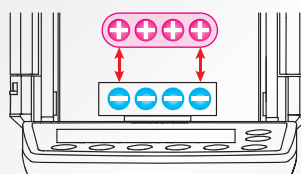

Error when a charged object approaches

The value will be shifted in the negative direction. Static induction from a charged object like clothing (frequent in dry winters) can be a cause of a drifting value.

Built-in Fanless Ionizer*

*Patent Pending

The internal ionizer neutralizes an electrostatically charged object instantly. Simply hold the sample in the neutralizing chamber for a second before placing it in the weighing chamber.

Direct-current (DC) method

The DC ionizer is fanless so you can even neutralize fine powders without having them blown away.

Long life of approximately 10,000 hours

The discharge electrode pins of the ionizer can be used continuously for approximately 10,000 hours and are safely replaceable.

Please also visit our video library at www.aandd.jp to see how you can easily eliminate static electricity from the sample!

Anti-static Breeze Break

The thin evaporated metal coating of the breeze break blocks outside static electricity.

IBM Series

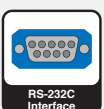



Neutralizing chamber

Separation plate

Weighing Chamber



The green LED is lit while the ionizer is on.



Just press the ION key to switch on the ionizer. The "ION" mark blinks on the display.

Motor-driven Internal Calibration Mass

The internal mass of the BM Series allows you to perform calibration quickly and correctly even if you are not skilled at calibrating balances using external masses.

Automatic Self Calibration

The balance can self-calibrate automatically when it detects a change in ambient temperature.

One Touch Automatic Calibration

The accuracy of your balance is assured with one key press.

Automatic Response Adjustment

Using the internal mass, the balance automatically adjusts its response characteristics (FAST, MID, or SLOW) by analyzing the influence of drafts or vibrations on the stability of the display value. (Manual adjustment is also possible.)



Special grated pans (left: ø50 mm, right: ø95 mm)

Special Pans for Weighing PM* Filters

The BM-20/22 includes two pans (ø50 mm and ø95 mm) for weighing PM filters as standard. These grated pans minimize the influence of drafts.

*Particulate matter

Large Weighing Chamber for Improved Usability*

*Patent Pending

To block drafts, A&D adopted a double-ring structure around the weighing pan and two vertical shields under the separation plate. This offers more space and easier operation than conventional 1 μ g balances with a secondary breeze break in the chamber.



Double-ring structure
(for BM-20/22)

A large flask or cylinder can be weighed by removing the separation plate (for a resolution of 10 μ g or higher).



Clear, White-backlit LCD

The contrast of black and white display provides excellent readability.

Interlockable Slide Doors

It is possible to slide a door open using the handle on the opposite side. Effective use of both hands lets you perform weighing more efficiently.



The "door" sign is displayed until the two side doors are completely closed.)

Built-in Environmental Sensors

The balance displays the temperature, humidity, and atmospheric pressure for users who need to record these environmental conditions.

Twelve Units of Weighing

You can easily select from g, mg, oz, ozt, ct, mom, dwt, GN, tael, tola, in addition to PC (counting mode) and % (percent mode).

Density Determination Function

For the BM-252/200/300/500, an optional density determination kit (AD-1653) is available for easy calculations of density.

Diverse Data Management Solutions

Data Memory Function

The balance can store up to 200 sets of weighing data (100 sets with date & time) or 50 sets of calibration history data.

GLP/GMP/GCP/ISO Compliant Output

In accordance with the Good Laboratory Practice (GLP), the balance can output the balance manufacturer, model, serial number, ID number, date, time, calibration mass used, space for signature, etc.

Two Types of Interfaces – RS-232C and Quick USB* (standard)

Two different devices (e.g. PC and remote controller) can be connected simultaneously to a balance. An external key plug for the optional foot switch (AX-SW128) is also provided as standard.



*Weighing data transfer from the balance to a PC only. Please use the AX-USB-9P for two-way communication or GLP output via USB.

LAN-Ethernet Interface (BM-08, optional) with WinCT-Plus Software

You can send commands for controlling and acquiring data from multiple balances.



AD-1688 Weighing Data Logger (Standard Accessory)

The AD-1688 is a handheld device (55 × 103 × 16.5 mm) that stores up to 5,000 weighing results with date and time. You can retrieve the saved data later by connecting the AD-1688 to a USB port of your computer (no driver software is necessary).



Save



Carry



and Retrieve the Data!

Specifications

	BM-20	BM-22	BM-252	BM-200	BM-300	BM-500
Weighing capacity	22 g	5.1 g / 22 g *	250 g	220 g	320 g	520 g
Minimum weighing value	0.001 mg	0.001 mg / 0.01 mg	0.01 mg	0.1 mg		
Repeatability (standard deviation)	0.0025 mg (for 1 g)	0.004 mg (for 1 g) / 0.01 mg	0.03 mg (for 100 g)	0.1 mg	0.2 mg	
Linearity	±0.010 mg	±0.010 mg / ±0.02 mg	±0.10 mg	±0.2 mg	±0.3 mg	±0.5 mg
Stabilization time (when set to FAST)	Approx. 10 secs	Approx. 10 secs / 8 secs	Approx. 8 secs	Approx. 3.5 secs		
Sensitivity drift (10 °C to 30 °C, when automatic self calibration is not used)	±2 ppm / °C					
Operating temperature	5 °C to 40 °C (41 °F to 104 °F), 85%RH or less (no condensation)					
Display refresh rate	5 times / second or 10 times / second					
Display mode	g, mg, oz, ozt, ct, mom, dwt, GN, tael, tola, PC (counting mode), % (percent mode), Specific gravity					
Counting mode	0.1 mg					
Minimum unit mass	0.1 mg					
Number of samples	10, 25, 50 or 100 pieces					
Percent mode	10.0 mg					
Minimum 100% reference mass	10.0 mg					
Minimum 100% display	0.01%, 0.1%, 1% (depends on the reference mass stored)					
Standard interface	RS-232C, Quick USB					
Internal calibration	Motor-driven internal calibration					
Applicable masses for external calibration	20 g 10 g 5 g 2 g 1 g	200 g 100 g 50 g 20 g 10 g	200 g 100 g 50 g	200 g 100 g 50 g	300 g 200 g 100 g 50 g	500 g 300 g 200 g 100 g 50 g
Discharge electrode pins of the ionizer	Life approx. 10,000 hours (continuous use)					
Weighing pan (diameter)	25 mm (50 mm, 95 mm for weighing filters)		90 mm			
Power consumption	Approx. 30 VA (supplied to the AC adaptor)					
External dimensions	259 (W) × 466 (D) × 326 (H) mm					
Net weight	Approx. 10 kg					
Standard accessories	AC adapter, Instruction manual, WinCT (CD-ROM), Weighing data logger (AD-1688), Tweezers for calibration mass (AD-1689), Tweezers and two weighing pans for PM filters (for BM-20/22 only)					

* Smart range function: The minimum weighing value will switch to 0.01 mg automatically when the display value exceeds 5.1 g but returns to 0.001 mg by pressing the RE-ZERO (tare) key.

Options

BM-08* Ethernet interface with WinCT-Plus software

* BM-08 and the standard Quick USB interface cannot be used at the same time.

Accessories

- AD-1651** Vibratory spoon
- AD-1653** Density determination kit (for BM-252/200/300/500 only)
- AD-1670** Anti-vibration table for balances
- AD-1682** Rechargeable battery unit
- AD-1684** Electrostatic fieldmeter
- AD-1688** Weighing data logger
- AD-1689** Tweezers for calibration mass
- AD-8121B** Compact printer
- AD-8526** Serial/Ethernet converter
- AD-8920A** Remote display
- AD-8922A** Remote controller
- AX-BM-031** Display covers (5 pcs)
- AX-BM-NEEDLESET** Electrode units
- AX-KO2466-200** RS-232C cable (9P-9P, 2 m)
- AX-SW128** Foot switch
- AX-T-314A-S** External key plug
- AX-USB-9P** Serial/USB converter



External Dimensions (mm/inches)

Pan size	Model	A
	BM-20/22	Ø25 / 0.98
	BM-252/200/300/500	Ø90 / 3.54

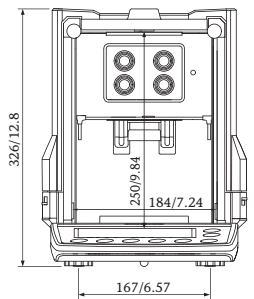
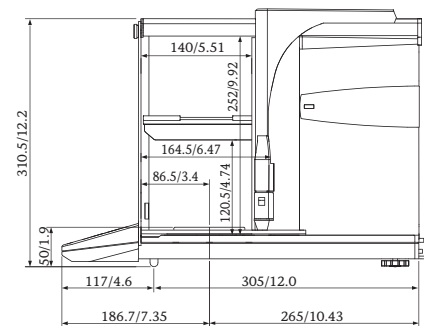
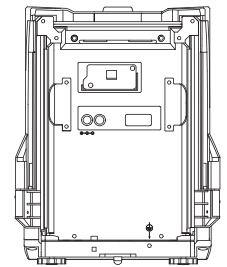
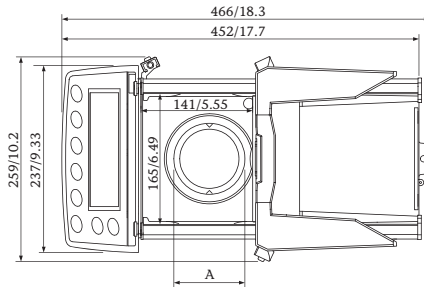

A&D Company, Limited

3-23-14 Higashi-Ikebukuro, Toshima-ku, Tokyo 170-0013 JAPAN
Telephone: [81](3) 5391-6132 Fax: [81](3) 5391-6148
http://www.aand.jp

A&D ENGINEERING, INC.

1756 Automation Parkway, San Jose, CA 95131 U.S.A.
Telephone: [1](408) 263-5333 Fax: [1](408) 263-0119

A&D Australasia Pty Ltd.

32 Dew Street, Thebarton, South Australia 5031 AUSTRALIA
Telephone: [61](8) 8301-8100 Fax: [61](8) 8352-7409

A&D INSTRUMENTS LTD.

Unit 24/26 Blacklands Way Abingdon Business Park,
Abingdon, Oxon OX14 1DY UNITED KINGDOM
Telephone: [44](1235) 550420 Fax: [44](1235) 550485

<German Sales Office>

Hamburger Straße 30 D-22926 Ahrensburg GERMANY
Telephone: [49](0) 4102 459230 Fax: [49](0) 4102 459231

A&D KOREA Limited

Manhattan Bldg. 8F, 36-2 Yoido-dong, Youngdeungpo-gu, Seoul, KOREA
Telephone: [82](2) 780-4101 Fax: [82](2) 782-4280

A&D RUS CO., LTD.

Vereyskaya str.17, Moscow, 121357 RUSSIA
Telephone: [7] (495) 937-33-44 Fax: [7] (495) 937-55-66

A&D Instruments India Private Limited

509 Udyog Vihar Phase V
Gurgaon-122 016, Haryana, INDIA
Telephone: [91](124) 471-5555 Fax: [91](124) 471-5599